



Micro Focus RM/COBOL

RM/COBOL
Syntax Summary

Micro Focus
The Lawn
22-30 Old Bath Road
Newbury, Berkshire RG14 1QN
UK
<http://www.microfocus.com>

© Copyright 2017-2020 Micro Focus or one of its affiliates.

The only warranties for products and services of Micro Focus and its affiliates and licensors (“Micro Focus”) are as may be set forth in the express warranty statements accompanying such products and services. Nothing herein should be construed as constituting an additional warranty. Micro Focus shall not be liable for technical or editorial errors or omissions contained herein. The information contained herein is subject to change without notice.

Revised 2020-05-07 for version 12.17

Contents

- RM/COBOL Commands..... 1**
 - Compile Command 1
 - Runtime Command 3
 - Debug Command 4

- RM/COBOL Language Syntax..... 9**
 - Source Program General Format..... 9
 - Identification Division General Format 9
 - Environment Division General Format 10
 - File Control Entry General Formats 12
 - Data Division General Format 14
 - file-description-entry 15
 - sort-merge-file-description-entry 15
 - record-description-entry..... 16
 - 77-level-description-entry..... 16
 - data-description-entry 16
 - communication-description-entry 19
 - screen-description-entry..... 20
 - Procedure Division General Formats..... 23
 - Procedure Division Verbs 24
 - ACCEPT Statement 24
 - ADD Statement..... 26
 - ALTER Statement 27
 - CALL Statement..... 27
 - CALL PROGRAM Statement 28
 - CANCEL Statement 28
 - CLOSE Statement..... 29
 - COMPUTE Statement 29
 - CONTINUE Statement 29
 - DELETE Statement 29
 - DELETE FILE Statement..... 29
 - DISABLE Statement 30
 - DISPLAY Statement 30
 - DIVIDE Statement..... 32
 - ENABLE Statement..... 33
 - ENTER Statement 33
 - EVALUATE Statement 34
 - EXIT Statement 34
 - GOBACK Statement 35
 - GO TO Statement 35
 - IF Statement..... 35
 - INITIALIZE Statement..... 36
 - INSPECT Statement 36

MERGE Statement	38
MOVE Statement.....	38
MULTIPLY Statement	38
OPEN Statement.....	39
PERFORM Statement.....	39
PURGE Statement	41
READ Statement	41
RECEIVE Statement	41
RELEASE Statement.....	42
RETURN Statement	42
REWRITE Statement.....	42
SEARCH Statement.....	42
SEND Statement.....	43
SET Statement	44
SORT Statement	45
START Statement.....	46
STOP Statement.....	46
STRING Statement	47
SUBTRACT Statement.....	47
UNLOCK Statement.....	48
UNSTRING Statement	48
USE Statement.....	49
WRITE Statement.....	49
END PROGRAM Header General Format	50
COPY and REPLACE Statement General Formats	50
General Formats for Conditions.....	51
General Formats for Qualification	53
Miscellaneous Formats	54
Sentence.....	54
Statement Sequence	54
Subscripting	55
Reference Modification	55
Identifier	55
Special Registers.....	55
Figurative Constants	56
Concatenation Expression.....	56
Constant-Expression	57
PICTURE Character-String (Data Categories).....	57
PICTURE Symbols.....	60
LIKE Pattern Grammar.....	63
Directives.....	69
Program Structure	70
General Format for Nested Source Programs	70
General Format for <i>nested-source-program</i>	70
General Format for a Sequence of Source Programs	71
COBOL Words	71
Reserved Words (A - B)	72
Reserved Words (C)	72
Reserved Words (D).....	73
Reserved Words (E).....	73
Reserved Words (F - I)	74
Reserved Words (J - N)	75
Reserved Words (O - Q).....	75
Reserved Words (R)	76
Reserved Words (S).....	76
Reserved Words (T - Z).....	77

Unused Reserved Words.....	77
Context-Sensitive Words.....	78
Nonreserved System-Names.....	80

RM/COBOL Language Examples..... 83

ACCEPT Statement Examples.....	83
Add Statement Example	87
Alter Statement Example	88
CALL Statement Example.....	89
CALL Program Statement Example	91
CANCEL Statement Example	92
CLOSE Statement Example.....	93
COMPUTE Statement Example	94
CONTINUE Statement Example.....	96
DELETE Statement Example	96
DELETE FILE Statement Example.....	98
DISABLE Statement Example.....	99
DISPLAY Statement Examples	99
DIVIDE Statement Example.....	102
ENABLE Statement Example.....	103
ENTER Statement Example	103
EVALUATE Statement Example	104
EXIT Statement Example	105
GOBACK Statement Example.....	107
GO TO Statement Example	107
IF Statement Example.....	108
INITIALIZE Statement Example.....	109
INSPECT Statement Example	110
MERGE Statement Example	115
MOVE Statement Example.....	116
MULTIPLY Statement Example	117
OPEN Statement Example.....	117
PERFORM Statement Example.....	119
PURGE Statement Example	120
READ Statement Examples.....	121
RECEIVE Statement Example.....	124
RELEASE Statement Example.....	125
RETURN Statement Example	126
REWRITE Statement Example.....	127
SEARCH Statement Example.....	128
SEND Statement Example	131
SET Statement Example	132
SORT Statement Example	133
START Statement Example.....	134
STOP Statement Example.....	136
STRING Statement Example.....	136
SUBTRACT Statement Example.....	137
UNLOCK Statement Example.....	138
UNSTRING Statement Example	139
USE Statement Example.....	140
WRITE Statement Examples	140

Index 143

RM/COBOL Commands

Compile Command

The format of the Compile Command is as follows:

```
rmcobol filename [[ ( [ option ] ... [ comment ] ) ]
```

filename is the name of the source file to be compiled.

option specifies a compiler option, described below. A tilde (~) preceding the option character negates the option. Options may be specified in either uppercase or lowercase letters. If an option is repeated in a command, the last occurrence of the option is used. Each option may be preceded by a hyphen. If any option is preceded by a hyphen, then a leading hyphen must precede all options. When assigning a value to an option, the equal sign is optional if leading hyphens are used.

comment is used to annotate the command.

A summary of the options for the Compile Command is shown in the following table. (For further information, see Chapter 6: *Compiling of the RM/COBOL User's Guide.*)

Option	Description
A	Directs the compiler to generate the allocation map in the listing.
B	Defines as binary sequential those sequential files not explicitly declared to be line sequential in their file control entries.
C[=<i>n</i>]	Suppresses the inclusion of copied text, replaced text, replacement text, or COPY statement text in the listing. <i>n</i> can be 0 to 15. Specifying C is equivalent to C=1.
D	Directs RM/COBOL to compile all source programs as if the WITH DEBUGGING MODE clause appeared in each compiled program.

Option	Description								
E	Suppresses the inclusion of the source program component in the listing except for lines associated with diagnostic messages.								
F ={(<i>keyword-list</i>) <i>keyword</i> }	<p>Directs the compiler to flag occurrences of these language elements:</p> <table> <tr> <td>COM1</td> <td>INTERMEDIATE</td> </tr> <tr> <td>COM2</td> <td>OBSOLETE</td> </tr> <tr> <td>EXTENSION</td> <td>SEG1</td> </tr> <tr> <td>HIGH</td> <td>SEG2</td> </tr> </table> <p>If leading hyphens are used, the parentheses are optional.</p>	COM1	INTERMEDIATE	COM2	OBSOLETE	EXTENSION	SEG1	HIGH	SEG2
COM1	INTERMEDIATE								
COM2	OBSOLETE								
EXTENSION	SEG1								
HIGH	SEG2								
G = <i>pathname</i>	Designates a file to be used as the primary compiler configuration.								
H = <i>pathname</i>	Designates a file as a supplement to the compiler configuration.								
K	Suppresses the banner message and the terminal error listing.								
L [= <i>pathname</i>]	Directs the compiler to produce a listing file and optionally specify the directory in which to place the listing file.								
M	Directs the compiler to suppress automatic input conversion for Format 1 and 3 ACCEPT statements with numeric operands and to suppress right justification of justified operands. Direct the compiler to suppress automatic output conversion for numeric fields of Format 3 DISPLAY statements.								
N	Suppresses the generation of an object program.								
O = <i>pathname</i>	Specifies the directory pathname where the object file will be placed.								
P	Directs the compiler to write a copy of the listing to the printer.								
Q	Directs the compiler to eliminate debugging information from generated object programs.								
R	Directs the compiler to generate a sequential number in the first six columns of source records as they appear on the listing.								
S	Directs the compiler to assume a separate sign when the SIGN clause is not specified for a DISPLAY usage, signed numeric data item (that is, for a data item whose character-string within a PICTURE clause begins with S).								
T	Directs the compiler to write a copy of the listing to the standard output device.								

Option	Description
U [={ B D P }]	Directs the compiler to assume an alternative usage for data items described as COMP or COMPUTATIONAL. <ul style="list-style-type: none"> The U Option specified alone or as U=B directs the compiler to assume BINARY usage for data items described as COMP or COMPUTATIONAL. The U=D Option directs the compiler to assume DISPLAY usage for items described as COMP or COMPUTATIONAL. The U=P Option directs the compiler to assume PACKED-DECIMAL usage for items described as COMP or COMPUTATIONAL.
V	Defines as line sequential those sequential files not explicitly declared to be binary sequential in their file control entries.
W = <i>n</i>	Specifies the amount of memory (in kilobytes) that the compiler should use for its internal table storage. <i>n</i> can be a decimal number from 32 to 524288.
X	Directs the compiler to generate a cross reference map in the listing.
Y [= <i>n</i>]	Directs the compiler to output the symbol table and debug line table to the object program file. <i>n</i> can be 0 to 3. Specifying Y is equivalent to Y=1.
Z = <i>version</i>	Indicates the object version of the RM/COBOL runtime you want to use. <i>version</i> can be 9 through 15.
2	Directs the compiler to accept source programs created for the RM/COBOL 2. <i>n</i> compiler.
7	Specifies the semantic rules under which the program is to be compiled as conforming to the American National Standard COBOL 1974.

Runtime Command

The format of the Runtime Command is as follows:

```
runcobol filename [ option ] ...
```

filename is the name of the main program of the run unit.

option specifies a runtime system option, described below. Options may be specified in either uppercase or lowercase letters. Each option may be preceded by a hyphen. If any option is preceded by a hyphen, then a leading hyphen must precede all options. When assigning a value to an option, the equal sign is optional if leading hyphens are used.

A summary of the options for the Runtime Command is shown in the following table. (For further information, see Chapter 7: *Running of the RM/COBOL User's Guide*.)

Option	Description
A =[<i>delim</i>] [<i>string</i>] [<i>delim</i>]	Passes an argument to the main program. The delimiter characters are optional if <i>string</i> does not contain spaces.
B = <i>n</i>	Specifies a maximum buffer size for use with the ACCEPT and DISPLAY statements.
C = <i>pathname</i>	Designates a file to be used as the primary runtime configuration file.
D	Invokes the RM/COBOL Interactive Debugger.
F = <i>fillchar</i>	Uses <i>fillchar</i> instead of space to preset read-write memory upon program load.
I	Collects RM/COBOL program instrumentation data.
K	Suppresses the banner message and the STOP RUN message.
L = <i>pathname</i>	Designates RM/COBOL non-COBOL subprogram libraries.
M	Directs that level 2 ANSI semantics are to be used for Format 1 ACCEPT and DISPLAY statements.
P [= Y N]	Directs that the runtime window be persistent or not persistent after the COBOL program terminates on Windows. (The P option is for Windows only; the P option is not valid or meaningful on UNIX.)
Q =[<i>delim</i>] [<i>string</i>] [<i>delim</i>]	Specifies the value used to initialize the SYMBOLIC QUEUE, SYMBOLIC SUB-QUEUE-1, SYMBOLIC SUB-QUEUE-2, and SYMBOLIC SUB-QUEUE-3 area in a CD FOR INITIAL INPUT record area or the SYMBOLIC TERMINAL area in a CD FOR INITIAL I-O record area. The delimiter characters are optional if <i>string</i> does not contain spaces.
S = <i>n . . . n</i>	Sets (or resets) the initial value of switches in the RM/COBOL program.
T = <i>n</i>	Specifies the amount of memory (<i>n</i> bytes) to be used for a sort operation.
V	Directs that a trace of support modules loaded by the RM/COBOL runtime system be displayed.
X = <i>pathname</i>	Designates a file as a supplement to the runtime configuration.

Debug Command

A summary of the options for the Debug Command are shown in the following table. (For further information on the Debug commands, see Chapter 9: *Debugging of the RM/COBOL User's Guide*.)

Note In the Address-Size formats for the D, M, T, and U commands, *base* is one of the following:

- **U** *arg-num* for a formal argument, and *arg-num* is the formal argument number.
- **B** *item-num* for a based linkage item, and *item-num* is the based linkage item number.
- **G** for the GIVING formal argument.
- **X** *ext-num* for an external data item, and *ext-num* is the external item number.

Command	Description
A (Address Stop)	<p>Sets a single-time breakpoint at a specific procedure division statement, paragraph, or section, and resumes program execution from the current location.</p> <p>A [<i>line</i> [+ <i>intra</i>line] [, [<i>prog-name</i>] [, [<i>count</i>]]]]</p>
B (Breakpoint)	<p>Sets a multi-time breakpoint at a specific procedure division statement, paragraph, or section, or displays all currently active breakpoints when the optional command operand is omitted.</p> <p>B [<i>line</i> [+ <i>intra</i>line] [, [<i>prog-name</i>] [, [<i>count</i>]]]]</p>
C (Clear)	<p>Clears an active breakpoint that has been set with the A or B Commands or clears all active breakpoints when the optional command operand is omitted.</p> <p>C [<i>line</i> [+ <i>intra</i>line] [, [<i>prog-name</i>]]]</p>
D (Display)	<p>Displays the value of a specified data item on the screen.</p> <p>Identifier Format</p> <p>D <i>name-1</i> [{ IN OF } <i>name-2</i>] ... [<i>script</i>] [<i>refmod</i>] [, { <i>type</i> { * & } [<i>type</i>] }] [# <i>alias</i>]</p> <p>Address-Size Format</p> <p>D [<i>base</i> :] <i>address</i> [+ <i>occur-size</i> * <i>occur-num</i>] ..., <i>size</i> , [<i>type</i>] [# <i>alias</i>]</p> <p>Alias Format</p> <p>D # <i>alias</i></p>
E (End)	<p>Ends debugging and resumes program execution.</p> <p>E</p>
L (Line Display)	<p>Specifies a line on the monitor screen at which command input echoes and Debug responses are to be displayed.</p> <p>L [<i>line-display</i>]</p>

Command	Description
M (Modify)	<p>Modifies the value of a specified data item.</p> <p>Identifier Format M <i>name-1</i> [{ IN OF } <i>name-2</i>] ... [<i>script</i>] [<i>refmod</i>] [, { <i>type</i> { * & } [<i>type</i>] }] [# <i>alias</i>] , <i>value</i></p> <p>Address-Size Format M [<i>base</i> :] <i>address</i> [+ <i>occur-size</i> * <i>occur-num</i>] ..., <i>size</i> , [<i>type</i>] [# <i>alias</i>] , <i>value</i></p> <p>Alias Format M # <i>alias</i> , <i>value</i></p>
Q (Quit)	<p>Quits debugging and program execution; control is returned to the operating system immediately as if a STOP RUN statement had been executed.</p> <p>Q</p>
R (Resume)	<p>Resumes program execution at the current location or at a specific procedure division statement, paragraph, or section specified in the command.</p> <p>R [<i>statement-address</i>]</p>
S (Step)	<p>Steps to the start of the next statement, paragraph, or section a specified number of times while tracing execution at each statement step. If P and S are omitted, a statement step is done. P specifies a step to next paragraph. S specifies a step to next section. A single step is done if <i>count</i> is omitted.</p> <p>S [P S] [<i>count</i>]</p>
T (Trap)	<p>Monitors the value of a specified data item, and suspends execution whenever a change in that value occurs; that is, activates a data trap or displays all activated data traps.</p> <p>Identifier Format T <i>name-1</i> [{ IN OF } <i>name-2</i>] ... [<i>script</i>] [<i>refmod</i>] [, { <i>type</i> { * & } [<i>type</i>] }] [# <i>alias</i>]</p> <p>Address-Size Format T [<i>base</i> :] <i>address</i> [+ <i>occur-size</i> * <i>occur-num</i>] ..., <i>size</i> , [<i>type</i>] [# <i>alias</i>]</p> <p>Alias Format T # <i>alias</i></p> <p>Display All Traps Format T</p>

Command	Description
U (Untrap)	<p>Clears some or all currently activated data traps.</p> <p>Identifier Format U <i>name-1</i> [{ IN OF } <i>name-2</i>] ... [<i>script</i>] [<i>refmod</i>] [, { <i>type</i> { * & } [<i>type</i>] }]</p> <p>Address-Size Format U [<i>base</i> :] <i>address</i> [+ <i>occur-size</i> * <i>occur-num</i>] ..., <i>size</i> , [<i>type</i>]</p> <p>Alias Format U # <i>alias</i></p> <p>Clear All Traps Format U</p>

RM/COBOL Language Syntax

Source Program General Format

identification-division
[*environment-division*]
[*data-division*]
[*procedure-division*]
[*nested-source-program*]...
[*end-program-header*]

Identification Division General Format

$\left\{ \begin{array}{l} \text{IDENTIFICATION} \\ \text{ID} \end{array} \right\} \text{ DIVISION.}$

$\text{PROGRAM-ID.} \left\{ \begin{array}{l} \textit{program-name-1} \\ \textit{literal-1} \end{array} \right\} \left[\text{ IS } \left\{ \left\{ \begin{array}{l} \text{COMMON} \\ \text{INITIAL} \end{array} \right\} \right\} \text{ PROGRAM} \right].$

[AUTHOR. [*comment-entry-1*]...]
[INSTALLATION. [*comment-entry-2*]...]
[DATE - WRITTEN. [*comment-entry-3*]...]
[DATE - COMPILED. [*comment-entry-4*]...]
[SECURITY. [*comment-entry-5*]...]

[REMARKS. [comment-entry-6]...]

Environment Division General Format

```

[
  ENVIRONMENT DIVISION .

  CONFIGURATION SECTION .

  SOURCE - COMPUTER . [ computer-name-1

    [ WITH DEBUGGING MODE ] . ] ]

  OBJECT - COMPUTER . [ computer-name-2

    [ MEMORY SIZE integer-1 { WORDS
                              CHARACTERS
                              MODULES } ]

    [ PROGRAM COLLATING SEQUENCE IS alphabet-name-1 ]

    [ SEGMENT-LIMIT IS segment-number-1 ] . ] ]

  SPECIAL - NAMES . [

    [ switch-name-1 { IS mnemonic-name-1 [ { ON STATUS IS condition-name-1
                                           OFF STATUS IS condition-name-2 } ] } ] ...

    feature-name-1 IS mnemonic-name-2

    low-volume-I-O-name-1 IS mnemonic-name-3

  ] ] ]

```

[ALPHABET *alphabet-name-1* IS

{
 STANDARD-1
 STANDARD-2
 NATIVE
 code-name-1
 { *literal-1* [{ THROUGH } *literal-2*] } ...
 [ALSO *literal-3* [{ THROUGH } *literal-4*]] ... } ...

[SYMBOLIC [CHARACTER CHARACTERS] { { *symbolic-character-1* } ... [IS ARE]

{ *integer-1* } ... } ... [IN *alphabet-name-2*] ...

[CLASS *class-name-1* IS { *literal-5* [{ THROUGH } *literal-6*] } ... } ...

[CURRENCY SIGN IS *literal-7*]

[DECIMAL-POINT IS COMMA]

[NUMERIC SIGN IS { LEADING TRAILING } [SEPARATE CHARACTER]]

[CONSOLE IS CRT]

[CURSOR IS *data-name-1*]

[CRT STATUS IS *data-name-2*] . [] [] []

[INPUT-OUTPUT SECTION.

FILE-CONTROL.

{ *file-control-entry-1* } ...

[I-O-CONTROL. [

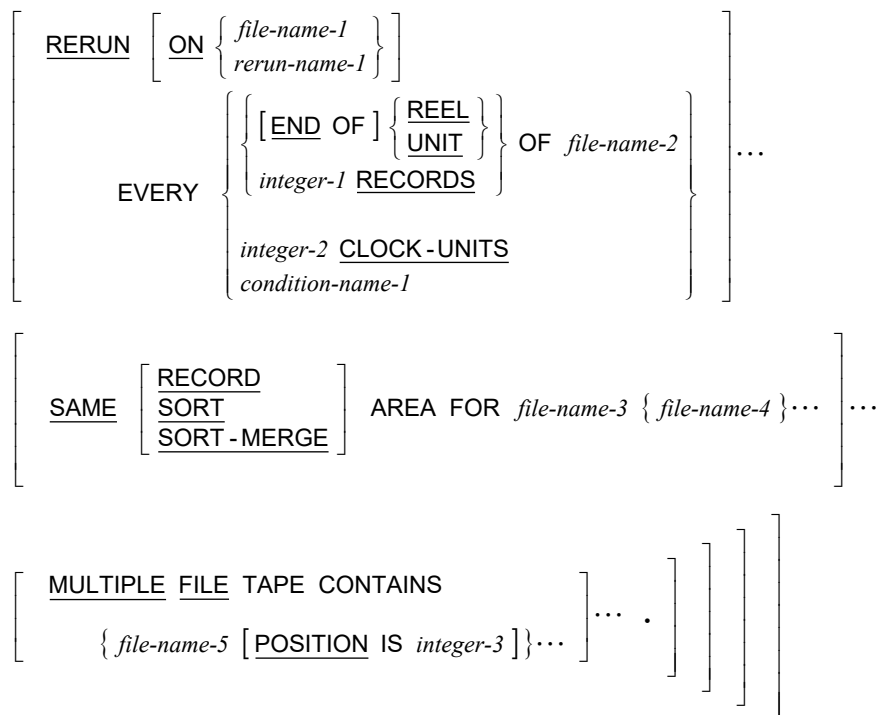

File Control Entry General Formats

file-control-entry

SELECT [[NOT] OPTIONAL] *file-name-1*

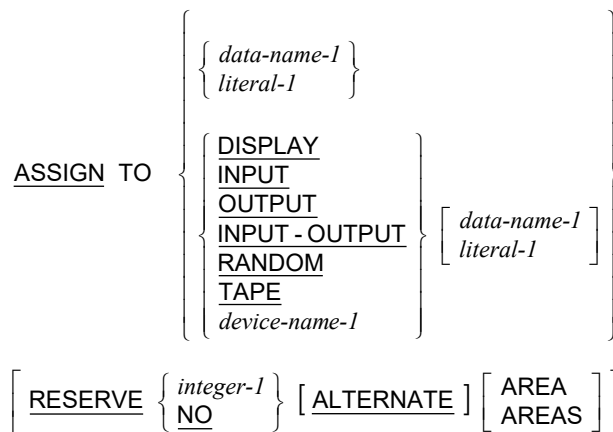

$$\left[\begin{array}{l}
 \left[\text{ORGANIZATION IS} \right] \left\{ \begin{array}{l}
 \left[\begin{array}{l} \text{BINARY} \\ \text{LINE} \end{array} \right] \text{SEQUENTIAL} \\
 \text{RELATIVE} \\
 \text{INDEXED}
 \end{array} \right\} \\
 \\
 \left[\text{PADDING CHARACTER IS} \left\{ \begin{array}{l} \text{data-name-2} \\ \text{literal-2} \end{array} \right\} \right] \\
 \\
 \left[\text{RECORD DELIMITER IS} \left\{ \begin{array}{l} \text{STANDARD-1} \\ \text{delimiter-name-1} \end{array} \right\} \right] \\
 \\
 \left[\text{ACCESS MODE IS} \left\{ \begin{array}{l} \text{SEQUENTIAL} \\ \text{RANDOM} \\ \text{DYNAMIC} \end{array} \right\} \left[\text{RELATIVE KEY IS data-name-3} \right] \right] \\
 \\
 \left[\text{LOCK MODE IS} \right. \\
 \left. \left\{ \begin{array}{l}
 \left\{ \begin{array}{l} \text{MANUAL} \\ \text{AUTOMATIC} \end{array} \right\} \left[\text{WITH LOCK ON} \left[\text{MULTIPLE} \right] \left\{ \begin{array}{l} \text{RECORD} \\ \text{RECORDS} \end{array} \right\} \right] \\
 \text{EXCLUSIVE}
 \end{array} \right\} \right] \\
 \\
 \left[\text{CODE-SET IS } \textit{alphabet-name-1} \right] \\
 \\
 \left[\text{COLLATING SEQUENCE IS } \textit{alphabet-name-2} \right] \\
 \\
 \left[\text{RECORD KEY IS} \left\{ \begin{array}{l} \text{data-name-4} \\ \text{split-key-name-1} = \{ \text{data-name-5} \} \dots \end{array} \right\} \right] \\
 \\
 \left[\text{WITH DUPLICATES} \right] \\
 \\
 \left[\text{ALTERNATE RECORD KEY IS} \left\{ \begin{array}{l} \text{data-name-6} \\ \text{split-key-name-2} = \{ \text{data-name-7} \} \dots \end{array} \right\} \right] \\
 \\
 \left[\text{WITH DUPLICATES} \right] \dots \\
 \\
 \left[\text{FILE STATUS IS } \textit{data-name-8} \right] .
 \end{array} \right.$$

sort-merge-file-control-entry

SELECT *file-name-1*

$$\text{ASSIGN TO } \left\{ \begin{array}{l} \left\{ \begin{array}{l} \text{data-name-1} \\ \text{literal-1} \end{array} \right\} \\ \left\{ \begin{array}{l} \text{SORT} \\ \text{SORT - MERGE} \\ \text{MERGE} \\ \text{device-name-1} \end{array} \right\} \left[\begin{array}{l} \text{data-name-1} \\ \text{literal-1} \end{array} \right] \end{array} \right\} .$$

Data Division General Format

[DATA DIVISION.

[FILE SECTION.

[*file-description-entry-1* { *record-description-entry-1* } ...
sort-merge-file-description-entry-1 { *record-description-entry-2* } ...] ...]

[WORKING-STORAGE SECTION.

[*77-level-description-entry-1*] ...
record-description-entry-3] ...]

[LINKAGE SECTION.

[*77-level-description-entry-2*] ...
record-description-entry-4] ...]

[COMMUNICATION SECTION.

[*communication-description-entry-1* { *record-description-entry-5* } ...] ...]

[SCREEN SECTION.

[*screen-description-entry-1*] ...]]

file-description-entry

FD *file-name-1*

[IS EXTERNAL]

[IS GLOBAL]

[BLOCK CONTAINS [*integer-1* TO] *integer-2* { RECORDS
CHARACTERS }]

[RECORD { CONTAINS [*integer-3* TO] *integer-4* CHARACTERS
IS VARYING IN SIZE
[[FROM *integer-5*] [TO *integer-6*] CHARACTERS]
[DEPENDING ON *data-name-1*] }]

[LABEL { RECORD IS
RECORDS ARE } { STANDARD
OMITTED }]

[VALUE OF { { LABEL
label-name-1 } IS { *data-name-2*
literal-1 } } ...]

[DATA { RECORD IS
RECORDS ARE } { *data-name-3* } ...]

[LINAGE IS { *data-name-4*
integer-7 } LINES [WITH FOOTING AT { *data-name-5*
integer-8 }]

[LINES AT TOP { *data-name-6*
integer-9 }] [LINES AT BOTTOM { *data-name-7*
integer-10 }]]

[CODE-SET IS *alphabet-name-1*] .

sort-merge-file-description-entry

SD *file-name-1*

$$\left[\begin{array}{l} \left\{ \begin{array}{l} \text{RECORD} \left\{ \begin{array}{l} \text{CONTAINS } [\text{integer-3 TO }] \text{ integer-4 CHARACTERS} \\ \text{IS VARYING IN SIZE} \\ \left[[\text{FROM } \text{integer-5}] [\text{TO } \text{integer-6}] \text{ CHARACTERS} \right] \\ [\text{DEPENDING ON } \text{data-name-1}] \end{array} \right\} \end{array} \right\} \\ \left\{ \begin{array}{l} \text{DATA} \left\{ \begin{array}{l} \text{RECORD IS} \\ \text{RECORDS ARE} \end{array} \right\} \left\{ \text{data-name-3} \right\} \dots \end{array} \right\} \end{array} \right].$$

record-description-entry

$\{ \text{data-description-entry-1} \} \dots$

77-level-description-entry

$\text{data-description-entry-2}$

data-description-entry

See also [PICTURE Character-String \(Data Categories\)](#) on pages 57 and [PICTURE Symbols](#) on page 60.

Format 1: Data-Name Full Declaration

$\text{level-number-1} \left[\begin{array}{l} \text{data-name-1} \\ \text{FILLER} \end{array} \right]$

$[\text{REDEFINES } \text{data-name-2}]$

$[\text{IS EXTERNAL}]$

$[\text{IS GLOBAL}]$

$\left[\left\{ \begin{array}{l} \text{PICTURE} \\ \text{PIC} \end{array} \right\} \text{ IS } \text{character-string-1} \right]$

[USAGE IS { BINARY [(*integer-3*)]
COMPUTATIONAL
COMP
COMPUTATIONAL-1
COMP-1
COMPUTATIONAL-3
COMP-3
COMPUTATIONAL-4 [(*integer-3*)]
COMP-4 [(*integer-3*)]
COMPUTATIONAL-5 [(*integer-3*)]
COMP-5 [(*integer-3*)]
COMPUTATIONAL-6
COMP-6
DISPLAY
INDEX
PACKED-DECIMAL
POINTER }]

[[SIGN IS] { LEADING
TRAILING } [SEPARATE CHARACTER]]

[OCCURS { *integer-2* TIMES
{ [*integer-1* TO] *integer-2* TIMES DEPENDING ON *data-name-3* } }]

[{ ASCENDING
DESCENDING } KEY IS { *data-name-4* } ...] ...

[INDEXED BY { *index-name-1* } ...]]

[{ SYNCHRONIZED
SYNC } [LEFT
RIGHT]]

[{ JUSTIFIED
JUST } RIGHT]

[BLANK WHEN ZERO]

[SAME AS *data-name-5*]

[VALUE IS *literal-1*] .

Format 2: Data-Name Renames

66 *data-name-1*

RENAMES *data-name-2* [{ THROUGH } THRU] *data-name-3*] .

Format 3: Condition-Name Declaration

88 *condition-name-1*

{ VALUE IS
VALUES ARE } { *literal-1* [{ THROUGH } THRU] *literal-2*]
relational-operator *literal-1* } ...

[WHEN SET TO FALSE IS *literal-3*] .

Format 4: Constant-Name Declaration

78 *constant-name-1*

VALUE IS { *literal-1*
constant-expression-1 } .

communication-description-entry

Format 1: Input CD

```

CD cd-name-1 FOR [ INITIAL ] INPUT
    {
        {
            SYMBOLIC QUEUE IS data-name-1
            SYMBOLIC SUB-QUEUE-1 IS data-name-2
            SYMBOLIC SUB-QUEUE-2 IS data-name-3
            SYMBOLIC SUB-QUEUE-3 IS data-name-4
            MESSAGE DATE IS data-name-5
            MESSAGE TIME IS data-name-6
            SYMBOLIC SOURCE IS data-name-7
            TEXT LENGTH IS data-name-8
            END KEY IS data-name-9
            STATUS KEY IS data-name-10
            MESSAGE COUNT IS data-name-11
        }
        {
            data-name-1 data-name-2 data-name-3 data-name-4
            data-name-5 data-name-6 data-name-7 data-name-8
            data-name-9 data-name-10 data-name-11
        }
    }

```

Format 2: Output CD

```

CD cd-name-1 FOR OUTPUT
    [ DESTINATION COUNT IS data-name-1 ]
    [ TEXT LENGTH IS data-name-2 ]
    [ STATUS KEY IS data-name-3 ]
    [ DESTINATION TABLE OCCURS integer-1 TIMES ]
      [ INDEXED BY { index-name-1 }... ]
    [ ERROR KEY IS data-name-4 ]
    [ SYMBOLIC DESTINATION IS data-name-5 ].

```

Format 3: Input-Output CD

```
CD cd-name-1 FOR [INITIAL] I-O  
[  
  {  
    MESSAGE DATE IS data-name-1  
    MESSAGE TIME IS data-name-2  
    SYMBOLIC TERMINAL IS data-name-3  
    TEXT LENGTH IS data-name-4  
    END KEY IS data-name-5  
    STATUS KEY IS data-name-6  
  }  
  {  
    data-name-1 data-name-2 data-name-3 data-name-4  
    data-name-5 data-name-6  
  }  
]
```

screen-description-entry

Format 1: Screen Group

```
level-number-1 [ screen-name-1 ]  
  FILLER  
  
  [ BACKGROUND IS color-name-1 ]  
  [ BACKGROUND-COLOR IS integer-1 ]  
  
  [ FOREGROUND IS color-name-2 ]  
  [ FOREGROUND-COLOR IS integer-2 ]  
  
  [[ USAGE IS ] DISPLAY ]  
  
  [ [ SIGN IS ] { LEADING  
  TRAILING } [ SEPARATE CHARACTER ] ]  
  
  [ AUTO  
  AUTO-SKIP ]  
  
  [ SECURE ]  
  
  [ REQUIRED ]  
  
  [ FULL ] .  
  
  { screen-description-entry-1 } ...
```

Format 2: Screen Literal

```
level-number-1 [ screen-name-1 ]  
  FILLER
```

[BELL
BEEP]

[BLANK { SCREEN
LINE
REMAINDER }]

[BLINK]

[ERASE { EOS
EOL
SCREEN }]

[[NO] HIGHLIGHT
LOWLIGHT]

[REVERSE
REVERSED
REVERSE - VIDEO]

[UNDERLINE]

[BACKGROUND IS *color-name-1*
BACKGROUND - COLOR IS *integer-1*]

[FOREGROUND IS *color-name-2*
FOREGROUND - COLOR IS *integer-2*]

[LINE [NUMBER IS { [PLUS
+] *integer-3* }
identifier-1 }]]

[{ COLUMN
COL } [NUMBER IS { [PLUS
+] *integer-4* }
identifier-2 }]]

[[VALUE IS] *literal-1*] .

Format 3: Screen Field

level-number-1 [*screen-name-1*
FILLER]

[BELL
BEEP]

[BLANK { SCREEN
LINE
REMAINDER }]

[BLINK]

[ERASE { EOS
EOL
SCREEN }]

[[NO] HIGHLIGHT
LOWLIGHT]

[REVERSE
REVERSED
REVERSE-VIDEO]

[UNDERLINE]

[BACKGROUND IS *color-name-1*
BACKGROUND-COLOR IS *integer-1*]

[FOREGROUND IS *color-name-2*
FOREGROUND-COLOR IS *integer-2*]

[LINE [NUMBER IS { [PLUS
+] *integer-3* }]]
identifier-1]]

[{ COLUMN
COL } [NUMBER IS { [PLUS
+] *integer-4* }]]
identifier-2]]

{ PICTURE
PIC } IS *character-string-1* { { FROM { *identifier-7*
literal-1 } } }
{ TO *identifier-8* } }
{ USING *identifier-9* } }

[[USAGE IS] DISPLAY]

[BLANK WHEN ZERO]

[{ JUSTIFIED
JUST } RIGHT]

[[SIGN IS] { LEADING
TRAILING } [SEPARATE CHARACTER]]

[AUTO
AUTO-SKIP]

[SECURE]

[REQUIRED]

[FULL] .

Procedure Division General Formats

Format 1: Declaratives or Sections

$$\left[\left[\left[\left[\text{PROCEDURE DIVISION} \left[\left[\left[\text{USING } \{ \textit{data-name-1} \} \dots \right] \left[\left\{ \begin{array}{l} \text{GIVING} \\ \text{RETURNING} \end{array} \right\} \textit{data-name-2} \right] \right] \right] \right] \right] \right] \right] .$$

$\left[\text{DECLARATIVES} .$
 $\{ \textit{section-name-1} \text{ SECTION } [\textit{segment-number-1}] .$
 $\quad \textit{USE-statement-1} .$
 $[\textit{paragraph-name-1} .$
 $\quad [\textit{sentence-1}] \dots [\dots] \dots \} \dots$
 $\text{END DECLARATIVES} . \left. \right]$
 $\{ \textit{section-name-2} \text{ SECTION } [\textit{segment-number-2}] .$
 $[\textit{paragraph-name-2} .$
 $\quad [\textit{sentence-2}] \dots [\dots] \dots \} \dots \left. \right]$

Format 2: Paragraphs

$$\left[\left[\left[\left[\text{PROCEDURE DIVISION} \left[\left[\left[\text{USING } \{ \textit{data-name-1} \} \dots \right] \left[\left\{ \begin{array}{l} \text{GIVING} \\ \text{RETURNING} \end{array} \right\} \textit{data-name-2} \right] \right] \right] \right] \right] \right] \right] .$$

$\{ \textit{paragraph-name-3} .$
 $\quad [\textit{sentence-3}] \dots [\dots] \dots \left. \right]$

Procedure Division Verbs

This section presents the syntax of each Procedure Division statement. For detailed information on the syntax and meaning of each Procedure Division statement, see the *RM/COBOL Language Reference Manual*.

[Examples](#) illustrating the RM/COBOL language syntax for the procedure division verbs begin on page 83.

ACCEPT Statement

Format 1: Accept From System-Name

ACCEPT *identifier-1* [FROM { *mnemonic-name-3*
low-volume-I-O-name-1 }] [END - ACCEPT]

Format 2: Accept From Implicit Definition

ACCEPT *identifier-2* FROM { CENTURY - DATE
CENTURY - DAY
DATE [YYYYMMDD]
DATE - AND - TIME
DATE - COMPILED
DAY [YYYYDDD]
DAY - AND - TIME
DAY - OF - WEEK
ESCAPE KEY
EXCEPTION STATUS
TIME } [END - ACCEPT]

Format 3: Accept Terminal I-O

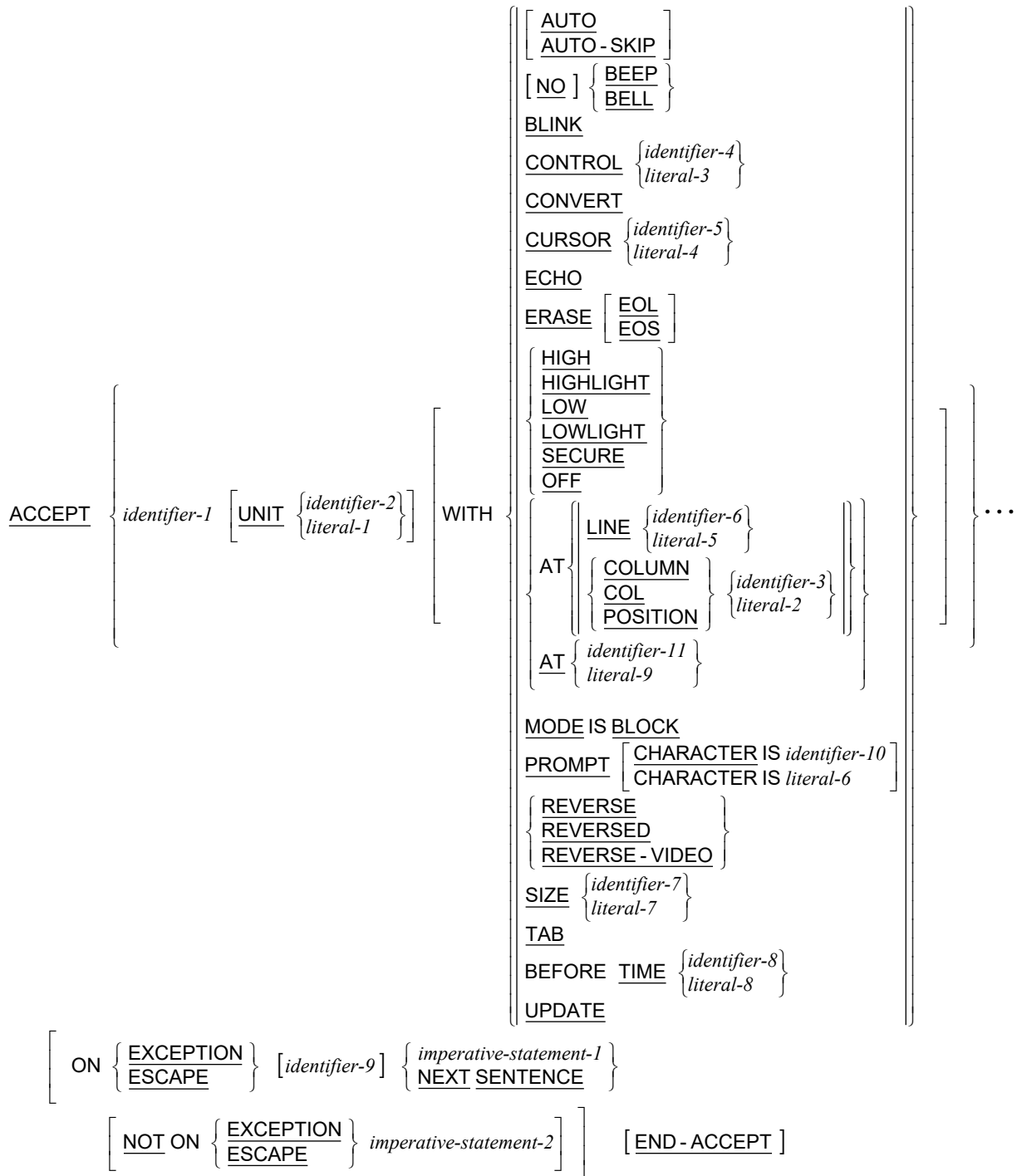

Format 4: Accept Input CD Message Count

`ACCEPT cd-name-1 MESSAGE COUNT [END-ACCEPT]`

Format 5: Accept Screen-Name

$$\text{ACCEPT } \textit{screen-name-1} \left[\begin{array}{l} \text{AT } \left\{ \begin{array}{l} \text{LINE NUMBER } \left\{ \begin{array}{l} \textit{identifier-1} \\ \textit{integer-1} \end{array} \right\} \\ \left\{ \begin{array}{l} \text{COLUMN} \\ \text{COL} \end{array} \right\} \text{NUMBER } \left\{ \begin{array}{l} \textit{identifier-2} \\ \textit{integer-2} \end{array} \right\} \end{array} \right\} \\ \text{AT } \left\{ \begin{array}{l} \textit{identifier-3} \\ \textit{integer-3} \end{array} \right\} \end{array} \right]$$

$$\left[\text{ON } \left\{ \begin{array}{l} \text{EXCEPTION} \\ \text{ESCAPE} \end{array} \right\} \textit{imperative-statement-1} \right]$$

$$\left[\text{NOT ON } \left\{ \begin{array}{l} \text{EXCEPTION} \\ \text{ESCAPE} \end{array} \right\} \textit{imperative-statement-2} \right]$$

$$\left[\text{END - ACCEPT} \right]$$

ADD Statement

Format 1: Add...To

$$\text{ADD } \left\{ \begin{array}{l} \textit{identifier-1} \\ \textit{literal-1} \end{array} \right\} \dots \text{ TO } \left\{ \begin{array}{l} \textit{identifier-2} \\ \text{ROUNDED} \end{array} \right\} \dots$$

$$\left[\text{ON } \text{SIZE ERROR } \textit{imperative-statement-1} \right]$$

$$\left[\text{NOT ON } \text{SIZE ERROR } \textit{imperative-statement-2} \right]$$

$$\left[\text{END - ADD} \right]$$

Format 2: Add...Giving

$$\text{ADD } \left\{ \begin{array}{l} \textit{identifier-1} \\ \textit{literal-1} \end{array} \right\} \dots \text{ TO } \left\{ \begin{array}{l} \textit{identifier-2} \\ \textit{literal-2} \end{array} \right\} \dots$$

$$\text{GIVING } \left\{ \begin{array}{l} \textit{identifier-3} \\ \text{ROUNDED} \end{array} \right\} \dots$$

$$\left[\text{ON } \text{SIZE ERROR } \textit{imperative-statement-1} \right]$$

$$\left[\text{NOT ON } \text{SIZE ERROR } \textit{imperative-statement-2} \right]$$

$$\left[\text{END - ADD} \right]$$

Format 3: Add Corresponding

ADD { CORRESPONDING
CORR } *identifier-1* TO *identifier-2* [ROUNDED]

[ON SIZE ERROR *imperative-statement-1*]

[NOT ON SIZE ERROR *imperative-statement-2*]

[END-ADD]

ALTER Statement

ALTER { *procedure-name-1* TO [PROCEED TO] *procedure-name-2* }...

CALL Statement

Format 1: Call...On Overflow

CALL { *identifier-1*
literal-1 } [{ USING { [BY REFERENCE] { *identifier-2*
OMITTED } ... }
BY CONTENT { *identifier-2*
literal-2
OMITTED } ... } ... }

{ GIVING
RETURNING } *identifier-3*]

[ON OVERFLOW *imperative-statement-1*]

[END-CALL]

Format 2: Call...On Exception

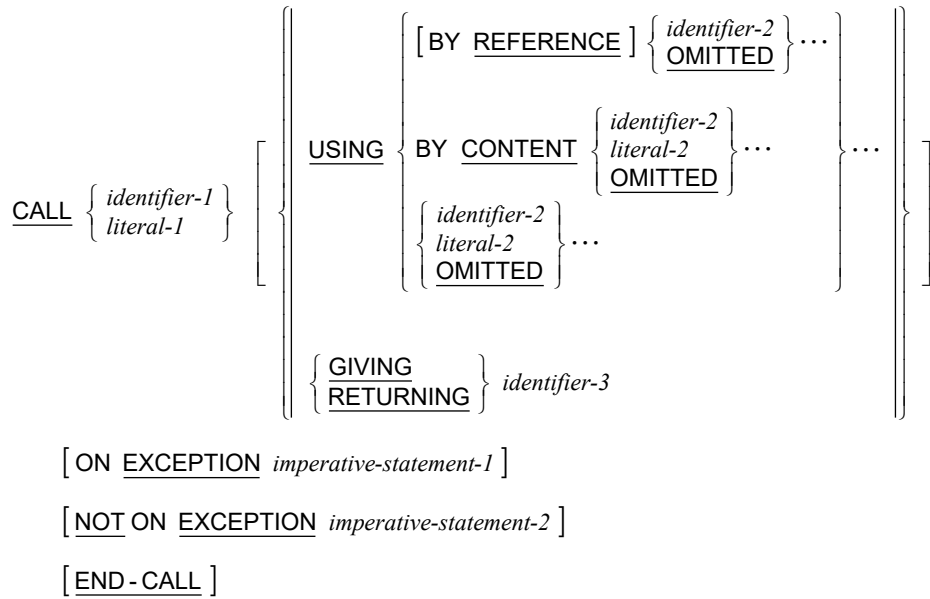

CALL PROGRAM Statement

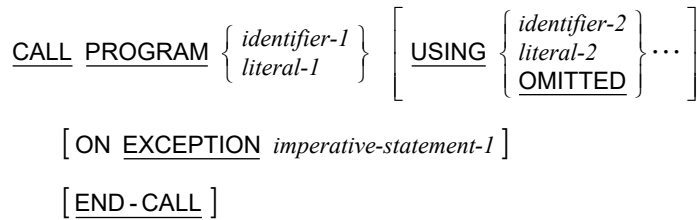

CANCEL Statement

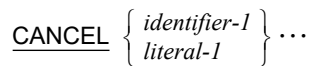

CLOSE Statement

$$\text{CLOSE } \left\{ \begin{array}{l} \text{file-name-1} \\ \left[\begin{array}{l} \left\{ \begin{array}{l} \text{REEL} \\ \text{UNIT} \end{array} \right\} \left[\begin{array}{l} \text{WITH NO REWIND} \\ \text{FOR REMOVAL} \end{array} \right] \\ \text{WITH } \left\{ \begin{array}{l} \text{NO REWIND} \\ \text{LOCK} \end{array} \right\} \end{array} \right] \end{array} \right\} \dots$$

COMPUTE Statement

COMPUTE { *identifier-1* [ROUNDED] } ... = *arithmetic-expression-1*
 [ON SIZE ERROR *imperative-statement-1*]
 [NOT ON SIZE ERROR *imperative-statement-2*]
 [END-COMPUTE]

CONTINUE Statement

CONTINUE

DELETE Statement

DELETE *file-name-1* RECORD
 [INVALID KEY *imperative-statement-1*]
 [NOT INVALID KEY *imperative-statement-2*]
 [END-DELETE]

DELETE FILE Statement

DELETE FILE { *file-name-2* } ... [END-DELETE]

DISABLE Statement

DISABLE $\left[\begin{array}{l} \text{INPUT } [\text{TERMINAL}] \\ \text{I-O } \text{TERMINAL} \\ \text{OUTPUT} \\ \text{TERMINAL} \end{array} \right] cd\text{-name-1} \left[\text{WITH } \underline{\text{KEY}} \left\{ \begin{array}{l} \text{identifier-1} \\ \text{literal-1} \end{array} \right\} \right]$

DISPLAY Statement

Format 1: Display Upon System-Name

DISPLAY $\left\{ \begin{array}{l} \text{identifier-1} \\ \text{literal-1} \end{array} \right\} \dots \left[\underline{\text{UPON}} \left\{ \begin{array}{l} \text{mnemonic-name-3} \\ \text{low-volume-I-O-name-1} \end{array} \right\} \right]$
 $\left[\text{WITH } \underline{\text{NO ADVANCING}} \right]$

Format 2: Display Terminal I-O

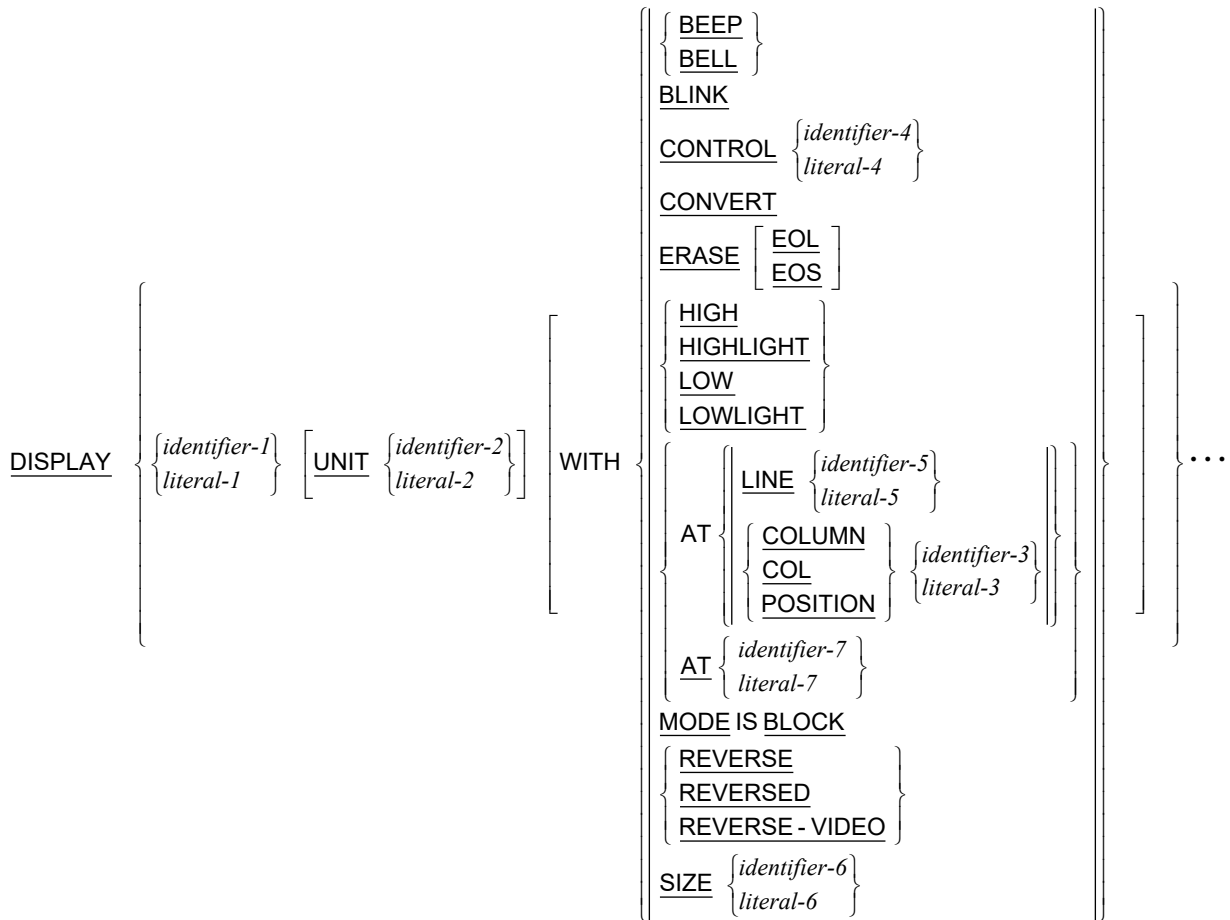

Format 3: Display Screen-Name

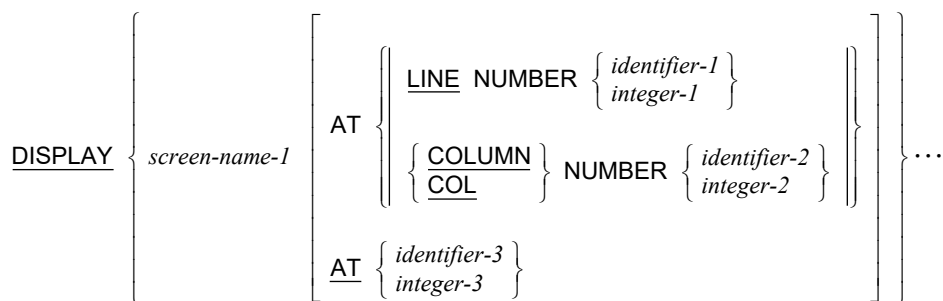

DIVIDE Statement

Format 1: Divide...Into

DIVIDE { *identifier-1* }
literal-1 } INTO { *identifier-2* [ROUNDED] }...
[ON SIZE ERROR *imperative-statement-1*]
[NOT ON SIZE ERROR *imperative-statement-2*]
[END-DIVIDE]

Format 2: Divide...Into...Giving

DIVIDE { *identifier-1* }
literal-1 } INTO { *identifier-2* }
literal-2 }
GIVING { *identifier-3* [ROUNDED] }...
[ON SIZE ERROR *imperative-statement-1*]
[NOT ON SIZE ERROR *imperative-statement-2*]
[END-DIVIDE]

Format 3: Divide...By...Giving

DIVIDE { *identifier-2* }
literal-2 } BY { *identifier-1* }
literal-1 }
GIVING { *identifier-3* [ROUNDED] }...
[ON SIZE ERROR *imperative-statement-1*]
[NOT ON SIZE ERROR *imperative-statement-2*]
[END-DIVIDE]

Format 4: Divide...Into...Giving...Remainder

DIVIDE { *identifier-1* }
 { *literal-1* } INTO { *identifier-2* }
 { *literal-2* }

 GIVING *identifier-3* [ROUNDED] REMAINDER *identifier-4*

 [ON SIZE ERROR *imperative-statement-1*]

 [NOT ON SIZE ERROR *imperative-statement-2*]

 [END-DIVIDE]

Format 5: Divide...By...Giving...Remainder

DIVIDE { *identifier-2* }
 { *literal-2* } BY { *identifier-1* }
 { *literal-1* }

 GIVING *identifier-3* [ROUNDED] REMAINDER *identifier-4*

 [ON SIZE ERROR *imperative-statement-1*]

 [NOT ON SIZE ERROR *imperative-statement-2*]

 [END-DIVIDE]

ENABLE Statement

ENABLE [INPUT [TERMINAL]]
 [I-O TERMINAL]
 [OUTPUT]
 [TERMINAL]] *cd-name-1* [WITH KEY { *identifier-1* }
 { *literal-1* }]

ENTER Statement

ENTER *language-name-1* [*routine-name-1*]

Note The sentence ENTER COBOL must follow the last statement of the other language in order to indicate to the compiler where a return to COBOL source language takes place. It must be followed by a separator space. However, RM/COBOL does not currently support any other language embedded within a COBOL program. The ENTER statement is supported for compatibility with some dialects of COBOL that require an ENTER LINKAGE sentence preceding a CALL statement and an ENTER COBOL sentence immediately following a CALL statement.

EVALUATE Statement

```

EVALUATE { identifier-1
           literal-1
           expression-1
           TRUE
           FALSE } [ ALSO { identifier-2
                             literal-2
                             expression-2
                             TRUE
                             FALSE } ] ...

{ WHEN { ANY
         condition-1
         TRUE
         FALSE
         [ NOT ] { { identifier-3
                    literal-3
                    arithmetic-expression-1 }
                  [ THROUGH
                    THRU ] { identifier-4
                             literal-4
                             arithmetic-expression-2 }
                  } } }

[ ALSO { ANY
         condition-2
         TRUE
         FALSE
         [ NOT ] { { identifier-5
                    literal-5
                    arithmetic-expression-3 }
                  [ THROUGH
                    THRU ] { identifier-6
                             literal-6
                             arithmetic-expression-4 }
                  } } } ] ... ] ...

imperative-statement-1 } ...

[ WHEN OTHER imperative-statement-2 ]

[ END-EVALUATE ]

```

EXIT Statement

Format 1: Exit Paragraph

EXIT

Format 2: Exit Program

EXIT PROGRAM

Format 3: Exit Perform

EXIT PERFORM [CYCLE]

Format 4: Exit Paragraph/Section

EXIT { PARAGRAPH
SECTION }

GOBACK Statement

GOBACK

GO TO Statement

Format 1: Go To (Alterable)

GO TO [*procedure-name-1*]

Format 2: Go To (Non-Alterable)

GO TO *procedure-name-1*

Format 3: Go To...Depending On

GO TO { *procedure-name-1* }... DEPENDING ON *identifier-1*

IF Statement

IF *condition-1* THEN { *statement-1*
NEXT SENTENCE }

[ELSE { *statement-2*
NEXT SENTENCE }]

[END-IF]

INITIALIZE Statement

INITIALIZE { *identifier-1* }... [WITH FILLER]

[{ ALL
category-name } TO VALUE]

[THEN REPLACING { *category-name* DATA BY { *identifier-2*
literal-1 } }...]

[THEN TO DEFAULT]

where *category-name* is:

{
ALPHABETIC
ALPHANUMERIC
ALPHANUMERIC - EDITED
DATA - POINTER
NUMERIC
NUMERIC - EDITED
}

INSPECT Statement

Format 1: Inspect...Tallying

INSPECT *identifier-1* TALLYING

{ *identifier-2* FOR {
CHARACTERS [{ BEFORE
AFTER } INITIAL { *identifier-4*
literal-2 } }...
ALL
LEADING { { *identifier-3* [{ BEFORE
AFTER } INITIAL { *identifier-4*
literal-2 } } }... }...
TRAILING { { *literal-1* } [{ BEFORE
AFTER } INITIAL { *identifier-4*
literal-2 } } }... }...
FIRST
} }... }...

Format 2: Inspect...Replacing

INSPECT *identifier-1* REPLACING

$$\left\{ \begin{array}{l} \text{CHARACTERS BY } \left\{ \begin{array}{l} \textit{identifier-5} \\ \textit{literal-3} \end{array} \right\} \left[\begin{array}{l} \text{BEFORE} \\ \text{AFTER} \end{array} \right] \text{INITIAL } \left\{ \begin{array}{l} \textit{identifier-4} \\ \textit{literal-2} \end{array} \right\} \dots \\ \left\{ \begin{array}{l} \text{ALL} \\ \text{LEADING} \\ \text{TRAILING} \\ \text{FIRST} \end{array} \right\} \left\{ \left\{ \begin{array}{l} \textit{identifier-3} \\ \textit{literal-1} \end{array} \right\} \text{BY } \left\{ \begin{array}{l} \textit{identifier-5} \\ \textit{literal-3} \end{array} \right\} \left[\begin{array}{l} \text{BEFORE} \\ \text{AFTER} \end{array} \right] \text{INITIAL } \left\{ \begin{array}{l} \textit{identifier-4} \\ \textit{literal-2} \end{array} \right\} \dots \right\} \dots \end{array} \right\} \dots$$

Format 3: Inspect...Tallying...Replacing

INSPECT *identifier-1* TALLYING

$$\left\{ \begin{array}{l} \textit{identifier-2} \text{ FOR } \left\{ \begin{array}{l} \text{CHARACTERS } \left[\begin{array}{l} \text{BEFORE} \\ \text{AFTER} \end{array} \right] \text{INITIAL } \left\{ \begin{array}{l} \textit{identifier-4} \\ \textit{literal-2} \end{array} \right\} \dots \\ \left\{ \begin{array}{l} \text{ALL} \\ \text{LEADING} \\ \text{TRAILING} \\ \text{FIRST} \end{array} \right\} \left\{ \left\{ \begin{array}{l} \textit{identifier-3} \\ \textit{literal-1} \end{array} \right\} \left[\begin{array}{l} \text{BEFORE} \\ \text{AFTER} \end{array} \right] \text{INITIAL } \left\{ \begin{array}{l} \textit{identifier-4} \\ \textit{literal-2} \end{array} \right\} \dots \right\} \dots \end{array} \right\} \dots \dots \end{array} \right\}$$

REPLACING

$$\left\{ \begin{array}{l} \text{CHARACTERS BY } \left\{ \begin{array}{l} \textit{identifier-5} \\ \textit{literal-3} \end{array} \right\} \left[\begin{array}{l} \text{BEFORE} \\ \text{AFTER} \end{array} \right] \text{INITIAL } \left\{ \begin{array}{l} \textit{identifier-4} \\ \textit{literal-2} \end{array} \right\} \dots \\ \left\{ \begin{array}{l} \text{ALL} \\ \text{LEADING} \\ \text{TRAILING} \\ \text{FIRST} \end{array} \right\} \left\{ \left\{ \begin{array}{l} \textit{identifier-3} \\ \textit{literal-1} \end{array} \right\} \text{BY } \left\{ \begin{array}{l} \textit{identifier-5} \\ \textit{literal-3} \end{array} \right\} \left[\begin{array}{l} \text{BEFORE} \\ \text{AFTER} \end{array} \right] \text{INITIAL } \left\{ \begin{array}{l} \textit{identifier-4} \\ \textit{literal-2} \end{array} \right\} \dots \right\} \dots \end{array} \right\} \dots$$

Format 4: Inspect...Converting

INSPECT *identifier-1* CONVERTING

$$\left\{ \begin{array}{l} \textit{identifier-6} \\ \textit{literal-4} \end{array} \right\} \text{ TO } \left\{ \begin{array}{l} \textit{identifier-7} \\ \textit{literal-5} \end{array} \right\} \left[\begin{array}{l} \text{BEFORE} \\ \text{AFTER} \end{array} \right] \text{INITIAL } \left\{ \begin{array}{l} \textit{identifier-4} \\ \textit{literal-2} \end{array} \right\} \dots$$

MERGE Statement

MERGE *file-name-1* { ON { ASCENDING
DESCENDING } KEY { *data-name-1* } ... } ...
[COLLATING SEQUENCE IS *alphabet-name-1*]
USING *file-name-2* { *file-name-3* } ...
{ OUTPUT PROCEDURE IS *procedure-name-1* [{ THROUGH
THRU } *procedure-name-2*] }
GIVING { *file-name-4* } ... }

MOVE Statement

Format 1: Move...To

MOVE { *identifier-1*
literal-1 } TO { *identifier-2* } ...

Format 2: Move Corresponding

MOVE { CORRESPONDING
CORR } *identifier-1* TO { *identifier-2* } ...

MULTIPLY Statement

Format 1: Multiply...By

MULTIPLY { *identifier-1*
literal-1 } BY { *identifier-2* [ROUNDED] } ...
[ON SIZE ERROR *imperative-statement-1*]
[NOT ON SIZE ERROR *imperative-statement-2*]
[END-MULTIPLY]

Format 2: Multiply...Giving

```

MULTIPLY { identifier-1 }
         { literal-1 } BY { identifier-2 }
                       { literal-2 }

         GIVING { identifier-3 [ ROUNDED ] }...

         [ ON SIZE ERROR imperative-statement-1 ]

         [ NOT ON SIZE ERROR imperative-statement-2 ]

         [ END-MULTIPLY ]

```

OPEN Statement

```

OPEN [ EXCLUSIVE ]

      { INPUT { file-name-1 [ WITH LOCK ] [ REVERSED
      WITH NO REWIND ] } }...
      { OUTPUT { file-name-2 [ WITH LOCK ] [ WITH NO REWIND ] } }...
      { I-O { file-name-3 [ WITH LOCK ] } }...
      { EXTEND { file-name-4 [ WITH LOCK ] } }...

```

PERFORM Statement

Format 1: Perform (Once)

```

PERFORM [ procedure-name-1 [ { THROUGH
                              { THRU } procedure-name-2 ] ]

          [ imperative-statement-1 END-PERFORM ]

```

Format 2: Perform...Times

PERFORM [*procedure-name-1* [{ THROUGH } { THRU } *procedure-name-2*]]

[{ *identifier-1* } { *integer-1* } TIMES]

[*imperative-statement-1* END-PERFORM]

Format 3: Perform...Until

PERFORM [*procedure-name-1* [{ THROUGH } { THRU } *procedure-name-2*]]

[WITH TEST [{ BEFORE } { AFTER }] UNTIL *condition-1*]

[*imperative-statement-1* END-PERFORM]

Format 4: Perform...Varying

PERFORM [*procedure-name-1* [{ THROUGH } { THRU } *procedure-name-2*]]

[WITH TEST [{ BEFORE } { AFTER }]]

VARYING [{ *identifier-2* } { *index-name-1* }] FROM [{ *identifier-3* } { *index-name-2* }] BY [{ *identifier-4* } { *literal-2* }]

UNTIL *condition-1*

[AFTER [{ *identifier-5* } { *index-name-3* }] FROM [{ *identifier-6* } { *index-name-4* }] BY [{ *identifier-7* } { *literal-4* }]]

[UNTIL *condition-2*] ...]

[*imperative-statement-1* END-PERFORM]

PURGE Statement

PURGE *cd-name-1*

READ Statement

Format 1: Read Sequential Access

READ *file-name-1* [NEXT
PREVIOUS] RECORD [{ WITH [NO] LOCK
INTO *identifier-1* }]
[AT END *imperative-statement-1*]
[NOT AT END *imperative-statement-2*]
[END-READ]

Format 2: Read Random Access

READ *file-name-1* RECORD [{ WITH [NO] LOCK
INTO *identifier-1* }]
[KEY IS { *data-name-1*
split-key-name-1 }]
[INVALID KEY *imperative-statement-1*]
[NOT INVALID KEY *imperative-statement-2*]
[END-READ]

RECEIVE Statement

RECEIVE *cd-name-1* { MESSAGE
SEGMENT } INTO *identifier-1*
[NO DATA *imperative-statement-1*]
[WITH DATA *imperative-statement-2*]
[END-RECEIVE]

RELEASE Statement

RELEASE *record-name-1* [FROM { *identifier-1*
literal-1 }]

RETURN Statement

RETURN *file-name-1* RECORD [INTO *identifier-1*]
[AT END *imperative-statement-1*]
[NOT AT END *imperative-statement-2*]
[END-RETURN]

REWRITE Statement

REWRITE *record-name-1* [FROM { *identifier-1*
literal-1 }]
[INVALID KEY *imperative-statement-1*]
[NOT INVALID KEY *imperative-statement-2*]
[END-REWRITE]

SEARCH Statement

Format 1: Search (Serial)

SEARCH *identifier-1* [VARYING { *identifier-2*
index-name-1 }]
[AT END *imperative-statement-1*]
{ WHEN *condition-1* { *imperative-statement-2* } } ...
[END-SEARCH]

Format 2: Search All (Binary)

SEARCH ALL *identifier-1*

[AT END *imperative-statement-1*]

WHEN { *data-name-1* { IS EQUAL TO } { *identifier-3*
literal-1
arithmetic-expression-1 } }
condition-name-1

[AND { *data-name-2* { IS EQUAL TO } { *identifier-4*
literal-2
arithmetic-expression-2 } }] ...

{ *imperative-statement-2*
NEXT SENTENCE }

[END-SEARCH]

SEND Statement

Format 1: Send (Simple)

SEND *cd-name-1* FROM { *identifier-1*
literal-1 }

Format 2: Send (Advancing/Replacing)

SEND *cd-name-1* [FROM { *identifier-1*
literal-1 }] WITH { *identifier-2*
ESI
EMI
EGI }

[{ BEFORE
AFTER } ADVANCING { { *identifier-3*
integer-1 } [LINE
LINES] }
{ *mnemonic-name-2*
PAGE } }]

[REPLACING LINE]

SET Statement

Format 1: Set Index

$$\underline{\text{SET}} \left\{ \left\{ \begin{array}{l} \text{index-name-1} \\ \text{identifier-1} \end{array} \right\} \dots \underline{\text{TO}} \left\{ \begin{array}{l} \text{index-name-2} \\ \text{identifier-2} \\ \text{integer-1} \end{array} \right\} \right\} \dots$$

Format 2: Set Index Up/Down

$$\underline{\text{SET}} \left\{ \left\{ \text{index-name-3} \right\} \dots \left\{ \begin{array}{l} \underline{\text{UP}} \\ \underline{\text{DOWN}} \end{array} \right\} \underline{\text{BY}} \left\{ \begin{array}{l} \text{identifier-3} \\ \text{integer-2} \end{array} \right\} \right\} \dots$$

Format 3: Set Switch On/Off

$$\underline{\text{SET}} \left\{ \left\{ \text{mnemonic-name-1} \right\} \dots \underline{\text{TO}} \left\{ \begin{array}{l} \underline{\text{ON}} \\ \underline{\text{OFF}} \end{array} \right\} \right\} \dots$$

Format 4: Set Condition-Name True/False

$$\underline{\text{SET}} \left\{ \left\{ \text{condition-name-1} \right\} \dots \underline{\text{TO}} \left\{ \begin{array}{l} \underline{\text{TRUE}} \\ \underline{\text{FALSE}} \end{array} \right\} \right\} \dots$$

Format 5: Set Pointer

$$\underline{\text{SET}} \left\{ \left\{ \begin{array}{l} \underline{\text{ADDRESS}} \left[\begin{array}{l} \underline{\text{IN}} \\ \underline{\text{OF}} \end{array} \right] \text{data-name-1} \\ \text{identifier-4} \end{array} \right\} \dots \underline{\text{TO}} \left\{ \begin{array}{l} \underline{\text{ADDRESS}} \left[\begin{array}{l} \underline{\text{IN}} \\ \underline{\text{OF}} \end{array} \right] \text{identifier-5} \\ \text{identifier-6} \\ \underline{\text{NULL}} \\ \underline{\text{NULLS}} \end{array} \right\} \right\} \dots$$

Format 6: Set Pointer Up/Down

$$\underline{\text{SET}} \left\{ \left\{ \begin{array}{l} \underline{\text{ADDRESS}} \left[\begin{array}{l} \underline{\text{IN}} \\ \underline{\text{OF}} \end{array} \right] \text{data-name-1} \\ \text{identifier-4} \end{array} \right\} \dots \left\{ \begin{array}{l} \underline{\text{UP}} \\ \underline{\text{DOWN}} \end{array} \right\} \underline{\text{BY}} \left\{ \begin{array}{l} \text{identifier-7} \\ \text{integer-3} \\ \underline{\text{LENGTH}} \left[\begin{array}{l} \underline{\text{IN}} \\ \underline{\text{OF}} \end{array} \right] \text{identifier-8} \end{array} \right\} \right\} \dots$$

SORT Statement

SORT *file-name-1* { ON { ASCENDING
DESCENDING } KEY { *data-name-1* }... }...
[WITH DUPLICATES IN ORDER]
[COLLATING SEQUENCE IS *alphabet-name-1*]
{ INPUT PROCEDURE IS *procedure-name-1* [{ THROUGH
THRU } *procedure-name-2*] }
USING { *file-name-2* }...
{ OUTPUT PROCEDURE IS *procedure-name-3* [{ THROUGH
THRU } *procedure-name-4*] }
GIVING { *file-name-3* }... }

START Statement

$$\text{START } \textit{file-name-1} \text{ KEY } \left\{ \begin{array}{l} \text{IS } [\text{NOT}] \text{ LESS THAN} \\ \text{IS } [\text{NOT}] < \\ \text{IS EQUAL TO} \\ \text{IS } = \\ \text{IS } [\text{NOT}] \text{ GREATER THAN} \\ \text{IS } [\text{NOT}] > \\ \text{IS GREATER THAN OR EQUAL TO} \\ \text{IS } \geq \\ \text{IS LESS THAN OR EQUAL TO} \\ \text{IS } \leq \\ \text{IS FIRST} \\ \text{IS LAST} \end{array} \right\} \left\{ \begin{array}{l} \textit{data-name-1} \\ \textit{split-key-name-1} \end{array} \right\}$$

$$\left[\text{WITH SIZE } \left\{ \begin{array}{l} \textit{identifier-1} \\ \textit{integer-1} \end{array} \right\} \right]$$

$$\left[\text{WHILE KEY IS } [\text{NOT}] \text{ LIKE } \left\{ \left\{ \begin{array}{l} \text{TRIMMED } \left[\begin{array}{l} \text{RIGHT} \\ \text{LEFT} \end{array} \right] \end{array} \right\} \right\} \left\{ \begin{array}{l} \text{CASE - INSENSITIVE} \\ \text{CASE - SENSITIVE} \end{array} \right\} \right\} \left\{ \begin{array}{l} \textit{identifier-2} \\ \textit{literal-1} \end{array} \right\} \right]$$

[INVALID KEY *imperative-statement-1*]

[NOT INVALID KEY *imperative-statement-2*]

[END-START]

STOP Statement

$$\text{STOP } \left\{ \begin{array}{l} \text{RUN } \left[\begin{array}{l} \textit{identifier-1} \\ \textit{integer-1} \end{array} \right] \\ \left\{ \begin{array}{l} \textit{identifier-2} \\ \textit{literal-1} \end{array} \right\} \end{array} \right\}$$

STRING Statement

STRING { { *identifier-1* }
 { *literal-1* } } ... DELIMITED BY { { *identifier-2* }
 { *literal-2* } }
 { SIZE } } ...

INTO *identifier-3*

[WITH POINTER *identifier-4*]

[ON OVERFLOW *imperative-statement-1*]

[NOT ON OVERFLOW *imperative-statement-2*]

[END-STRING]

SUBTRACT Statement

Format 1: Subtract...From

SUBTRACT { { *identifier-1* }
 { *literal-1* } } ... FROM { *identifier-3* [ROUNDED] } ...

[ON SIZE ERROR *imperative-statement-1*]

[NOT ON SIZE ERROR *imperative-statement-2*]

[END-SUBTRACT]

Format 2: Subtract...Giving

SUBTRACT { { *identifier-1* }
 { *literal-1* } } ... FROM { { *identifier-2* }
 { *literal-2* } }
GIVING { *identifier-3* [ROUNDED] } ...

[ON SIZE ERROR *imperative-statement-1*]

[NOT ON SIZE ERROR *imperative-statement-2*]

[END-SUBTRACT]

Format 3: Subtract Corresponding

SUBTRACT { CORRESPONDING
CORR } *identifier-1* FROM *identifier-2* [ROUNDED]
[ON SIZE ERROR *imperative-statement-1*]
[NOT ON SIZE ERROR *imperative-statement-2*]
[END-SUBTRACT]

UNLOCK Statement

UNLOCK *file-name-1* [RECORD
RECORDS]

UNSTRING Statement

UNSTRING *identifier-1*
[DELIMITED BY [ALL] { *identifier-2*
literal-1 } [OR [ALL] { *identifier-3*
literal-2 }] ...]
INTO { *identifier-4* [DELIMITER IN *identifier-5*] [COUNT IN *identifier-6*] } ...
[WITH POINTER *identifier-7*]
[TALLYING IN *identifier-8*]
[ON OVERFLOW *imperative-statement-1*]
[NOT ON OVERFLOW *imperative-statement-2*]
[END-UNSTRING]

USE Statement

$$\text{USE } [\text{GLOBAL}] \text{ AFTER STANDARD } \left\{ \begin{array}{l} \text{EXCEPTION} \\ \text{ERROR} \end{array} \right\}$$

$$\text{PROCEDURE ON } \left\{ \begin{array}{l} \{ \text{file-name-1} \} \dots \\ \text{INPUT} \\ \text{OUTPUT} \\ \text{I-O} \\ \text{EXTEND} \end{array} \right\}$$

WRITE Statement

Format 1: Write Sequential File

$$\text{WRITE } \textit{record-name-1} \left[\text{FROM } \left\{ \begin{array}{l} \textit{identifier-1} \\ \textit{literal-1} \end{array} \right\} \right]$$

$$\left[\begin{array}{l} \left\{ \begin{array}{l} \text{BEFORE} \\ \text{AFTER} \end{array} \right\} \text{ ADVANCING } \left\{ \begin{array}{l} \{ \textit{identifier-2} \} \left[\begin{array}{l} \text{LINE} \\ \text{LINES} \end{array} \right] \\ \text{TO LINE } \left\{ \begin{array}{l} \textit{identifier-3} \\ \textit{integer-2} \end{array} \right\} \left[\text{ON NEXT PAGE} \right] \\ \left\{ \begin{array}{l} \textit{mnemonic-name-2} \\ \text{PAGE} \end{array} \right\} \end{array} \right\} \right]$$

$$\left[\text{AT } \left\{ \begin{array}{l} \text{END-OF-PAGE} \\ \text{EOP} \end{array} \right\} \textit{imperative-statement-1} \right]$$

$$\left[\text{NOT AT } \left\{ \begin{array}{l} \text{END-OF-PAGE} \\ \text{EOP} \end{array} \right\} \textit{imperative-statement-2} \right]$$

$$\left[\text{END-WRITE} \right]$$

Format 2: Write Relative and Indexed File

$$\text{WRITE } \textit{record-name-1} \left[\text{FROM } \left\{ \begin{array}{l} \textit{identifier-1} \\ \textit{literal-1} \end{array} \right\} \right]$$

$$\left[\text{INVALID KEY } \textit{imperative-statement-1} \right]$$

$$\left[\text{NOT INVALID KEY } \textit{imperative-statement-2} \right]$$

$$\left[\text{END-WRITE} \right]$$

END PROGRAM Header General Format

```
END PROGRAM [ program-name-1 ]  
            [ literal-1 ] .
```

COPY and REPLACE Statement General Formats

The REPLACE statement and the REPLACING phrase of the COPY statement replace entire text words in the source. Sometimes it is desirable to replace a portion of a word.

Parentheses may be used to demarcate portions of words to be replaced because the left and right parenthesis characters are always treated as text word separators (the hyphen is not a text word separator) and replacement does not add additional spaces.

For example, suppose you wish to replace the first part of each identifier (before the initial hyphen). That is, you wish that the statement

```
COPY FDMASTER REPLACING ==FILENAME== BY ==WS==.
```

would, for the copy file containing

```
01 FILENAME-REC.  
02 FILENAME-ITEM1 ... .  
02 FILENAME-ITEM2 ... .
```

replace each occurrence of FILENAME. Unfortunately, this would not occur. The text words in the copy file are FILENAME-REC, FILENAME-ITEM1, and FILENAME-ITEM2, none of which match the replacing key text word FILENAME specified in the COPY statement REPLACING phrase.

The solution is to use parentheses in the COPY statement REPLACING phrase

```
COPY FDMASTER REPLACING ==(FILENAME)== BY ==WS==.
```

and in the copy file

```
01 (FILENAME)-REC.  
02 (FILENAME)-ITEM1 ... .  
02 (FILENAME)-ITEM2 ... .
```

The parentheses separate the names into multiple text words, which are then replaced as desired. Since no additional spaces are inserted, the replacement yields a single COBOL word in the resultant source program that is compiled.

$$\text{COPY } \left\{ \begin{array}{l} \textit{text-name-1} \\ \textit{literal-1} \end{array} \right\} \left[\left[\begin{array}{l} \text{IN} \\ \text{OF} \end{array} \right] \left\{ \begin{array}{l} \textit{library-name-1} \\ \textit{literal-2} \end{array} \right\} \right] \left[\text{SUPPRESS PRINTING} \right]$$

$$\left[\text{REPLACING } \left\{ \begin{array}{l} == \textit{pseudo-text-1} == \\ \textit{identifier-1} \\ \textit{literal-3} \\ \textit{word-1} \end{array} \right\} \text{ BY } \left\{ \begin{array}{l} == \textit{pseudo-text-2} == \\ \textit{identifier-2} \\ \textit{literal-4} \\ \textit{word-2} \end{array} \right\} \left\{ \dots \right\} \right]$$

$$\left[\text{END-COPY} \right]$$

Format 1: Begin or Change Replacement

$$\text{REPLACE } \left\{ == \textit{pseudo-text-1} == \text{ BY } == \textit{pseudo-text-2} == \right\} \dots \left[\text{END-REPLACE} \right]$$

Format 2: End Replacement

$$\text{REPLACE OFF } \left[\text{END-REPLACE} \right]$$

General Formats for Conditions

Relation Condition

$$\left\{ \begin{array}{l} \textit{identifier-1} \\ \textit{literal-1} \\ \textit{arithmetic-expression-1} \\ \textit{index-name-1} \end{array} \right\} \textit{relational-operator} \left\{ \begin{array}{l} \textit{identifier-2} \\ \textit{literal-2} \\ \textit{arithmetic-expression-2} \\ \textit{index-name-2} \end{array} \right\}$$

Relational Operator

$$\left. \begin{array}{l}
 \text{IS } [\text{NOT}] \text{ GREATER THAN} \\
 \text{IS } [\text{NOT}] > \\
 \text{IS } [\text{NOT}] \text{ LESS THAN} \\
 \text{IS } [\text{NOT}] < \\
 \text{IS } [\text{NOT}] \text{ EQUAL TO} \\
 \text{IS } [\text{NOT}] = \\
 \text{IS } \text{GREATER THAN OR EQUAL TO} \\
 \text{IS } \geq \\
 \text{IS } \text{LESS THAN OR EQUAL TO} \\
 \text{IS } \leq \\
 \\
 \text{IS } [\text{NOT}] \text{ LIKE } \left[\left[\left\{ \begin{array}{l} \text{TRIMMED } [\text{RIGHT} \\ \text{LEFT}] \end{array} \right\} \right] \left[\begin{array}{l} \text{CASE - INSENSITIVE} \\ \text{CASE - SENSITIVE} \end{array} \right] \right]
 \end{array} \right\}$$

LIKE Condition (special case of a relation condition)

$$\left\{ \begin{array}{l} \text{identifier-1} \\ \text{literal-1} \end{array} \right\} \text{ IS } [\text{NOT}] \text{ LIKE } \left[\left[\left\{ \begin{array}{l} \text{TRIMMED } [\text{RIGHT} \\ \text{LEFT}] \end{array} \right\} \right] \left[\begin{array}{l} \text{CASE - INSENSITIVE} \\ \text{CASE - SENSITIVE} \end{array} \right] \right] \left\{ \begin{array}{l} \text{identifier-2} \\ \text{literal-2} \end{array} \right\}$$

Class Condition

$$\text{identifier-1 IS } [\text{NOT}] \left\{ \begin{array}{l} \text{NUMERIC} \\ \text{ALPHABETIC} \\ \text{ALPHABETIC - LOWER} \\ \text{ALPHABETIC - UPPER} \\ \text{class-name-1} \end{array} \right\}$$

Sign Condition

$$\text{arithmetic-expression-1 IS } [\text{NOT}] \left\{ \begin{array}{l} \text{POSITIVE} \\ \text{NEGATIVE} \\ \text{ZERO} \end{array} \right\}$$

Condition-Name Condition

condition-name-1

Switch-Status Condition

condition-name-2

Negated Condition

NOT *condition-1*

Combined Condition

condition-2 { { AND } } *condition-3* } ...

Abbreviated Combined Relation Condition

relation-condition-1 { { AND } } [NOT] [*relational-operator*] *object-1* } ...

General Formats for Qualification

Format 1: Qualification for Data-Names, Index-Names and Condition-Names

$$\left\{ \begin{array}{l} \textit{data-name-1} \\ \textit{index-name-1} \\ \textit{condition-name-1} \end{array} \right\} \left\{ \begin{array}{l} \left\{ \left\{ \frac{\text{IN}}{\text{OF}} \right\} \textit{data-name-2} \right\} \cdots \left[\left\{ \frac{\text{IN}}{\text{OF}} \right\} \left\{ \begin{array}{l} \textit{file-name-1} \\ \textit{cd-name-1} \end{array} \right\} \right] \\ \left\{ \frac{\text{IN}}{\text{OF}} \right\} \left\{ \begin{array}{l} \textit{file-name-1} \\ \textit{cd-name-1} \end{array} \right\} \end{array} \right\}$$

Format 2: Qualification for LINAGE-COUNTER

LINAGE - COUNTER $\left\{ \begin{array}{c} \text{IN} \\ \text{OF} \end{array} \right\} \text{file-name-2}$

Format 3: Qualification for Screen-Names

screen-name-1 $\left\{ \left\{ \begin{array}{c} \text{IN} \\ \text{OF} \end{array} \right\} \text{screen-name-2} \right\} \dots$

Format 4: Qualification for Split-Key-Names

split-key-name-1 $\left\{ \begin{array}{c} \text{IN} \\ \text{OF} \end{array} \right\} \text{file-name-3}$

Format 5: Qualification for Paragraph Names

paragraph-name-1 $\left\{ \begin{array}{c} \text{IN} \\ \text{OF} \end{array} \right\} \text{section-name-1}$

Format 6: Qualification for Text-Names (COPY)

text-name-1 $\left\{ \begin{array}{c} \text{IN} \\ \text{OF} \end{array} \right\} \text{library-name-1}$

Miscellaneous Formats

Sentence

statement-sequence-1 .

Statement Sequence

$\left\{ \text{imperative-statement-1 THEN} \right\} \dots \left\{ \begin{array}{c} \text{imperative-statement-2} \\ \text{conditional-statement-1} \end{array} \right\}$

Subscripting

$$\left\{ \begin{array}{l} \text{data-name-1} \\ \text{condition-name-1} \end{array} \right\} \left(\begin{array}{l} \text{integer-1} \\ \left\{ \begin{array}{l} \text{data-name-2} \\ \text{index-name-1} \end{array} \right\} \left[\begin{array}{l} \{ + \} \\ \{ - \} \end{array} \right] \text{integer-2} \end{array} \right) \dots$$

Reference Modification

$$\text{data-name-1} \left(\text{leftmost-character-position-1} : \left[\text{length-1} \right] \left[\begin{array}{l} \{ \text{JUSTIFIED} \} \\ \{ \text{JUST} \} \end{array} \right] \text{RIGHT} \right)$$

Identifier

$$\text{data-name-1} \left[\begin{array}{l} \{ \text{IN} \} \\ \{ \text{OF} \} \end{array} \right] \text{data-name-2} \dots \left[\begin{array}{l} \{ \text{IN} \} \\ \{ \text{OF} \} \end{array} \right] \left\{ \begin{array}{l} \text{file-name-1} \\ \text{cd-name-1} \end{array} \right\}$$

$$\left[\left(\{ \text{subscript-1} \} \dots \right) \right]$$

$$\left[\left(\text{leftmost-character-position-1} : \left[\text{length-1} \right] \left[\begin{array}{l} \{ \text{JUSTIFIED} \} \\ \{ \text{JUST} \} \end{array} \right] \text{RIGHT} \right) \right]$$

Special Registers

ADDRESS $\left[\begin{array}{l} \text{IN} \\ \text{OF} \end{array} \right]$ *identifier-1*

COUNT $\left[\begin{array}{l} \text{IN} \\ \text{OF} \end{array} \right]$ *data-name-1*

COUNT-MAX $\left[\begin{array}{l} \text{IN} \\ \text{OF} \end{array} \right]$ *data-name-1*

COUNT-MIN $\left[\begin{array}{l} \text{IN} \\ \text{OF} \end{array} \right]$ *data-name-1*

HIGHEST-VALUE $\left[\begin{array}{l} \text{IN} \\ \text{OF} \end{array} \right]$ *identifier-1*

INITIAL-VALUE $\left[\begin{array}{l} \text{IN} \\ \text{OF} \end{array} \right]$ *data-name-1*

LENGTH $\left[\begin{array}{l} \text{IN} \\ \text{OF} \end{array} \right]$ $\left\{ \begin{array}{l} \text{identifier-1} \\ \text{literal-1} \end{array} \right\}$

LINAGE - COUNTER [{ IN / OF } *file-name-1*]

LOWEST - VALUE [IN / OF] *identifier-1*

MAX - VALUE [IN / OF] *identifier-1*

MIN - VALUE [IN / OF] *identifier-1*

PROCEDURE - NAME [IN / OF] { PARAGRAPH / PROCEDURE / SECTION }

PROGRAM - ID

RETURN - CODE

WHEN - COMPILED

Figurative Constants

[ALL] HIGH - VALUE

[ALL] HIGH - VALUES

[ALL] LOW - VALUE

[ALL] LOW - VALUES

[ALL] NULL

[ALL] NULLS

[ALL] QUOTE

[ALL] QUOTES

[ALL] SPACE

[ALL] SPACES

[ALL] ZERO

[ALL] ZEROES

[ALL] ZEROS

ALL *literal-1*

[ALL] *symbolic-character-1*

Concatenation Expression

literal-1 & *literal-2*

Constant-Expression

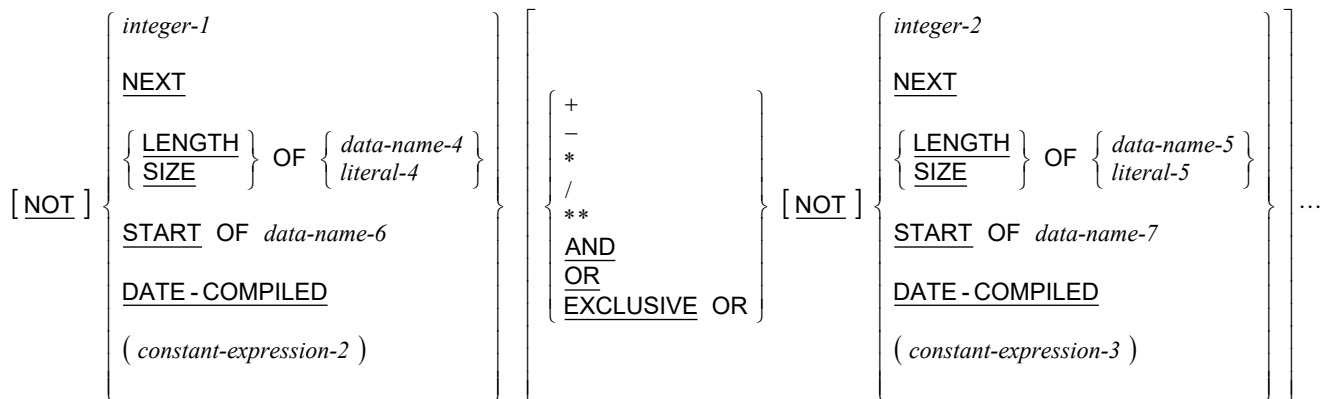

PICTURE Character-String (Data Categories)

The five categories of data that can be described with a PICTURE clause are defined as follows. Note that the additional data categories, **index data** and **data pointer**, also exist, but do not use a PICTURE clause in their data description entry. An index data item is described with the USAGE IS INDEX clause. A data pointer data item is described with the USAGE IS POINTER clause.

Note The additional data categories, index data and data pointer, also exist, but do not use a PICTURE clause in their data description entry. An index data item is described with the USAGE IS INDEX clause. A data pointer data item is described with the USAGE IS POINTER clause.

Alphabetic

Its PICTURE character-string can contain only the symbol **A**. The contents of an alphabetic data item when represented in standard data format must be one or more alphabetic characters ("a" through "z", "A" through "Z", and space). See the [examples](#) on page 58.

Alphanumeric

Its PICTURE character-string is restricted to certain combinations of the symbols **A**, **X** and **9**, and the item is treated as if the character-string contained all symbols **X**. The PICTURE character-string must contain at least one symbol **X** or a combination of the symbols **A** and **9**. A PICTURE character-string that contains all symbols **A** or all symbols **9** does not define an alphanumeric data item, since such character-strings define an alphabetic or numeric data item, respectively. The contents of an alphanumeric data item when represented in standard data format must be one or more characters in the character set of the computer. See the [examples](#) on page 58.

Alphanumeric edited

Its PICTURE character-string is restricted to certain combinations of the following symbols: **A**, **X**, **9**, **B**, **O**, and slash (/). The PICTURE character-string must contain at least one symbol **A** or **X** and at least one symbol **B**, **O**, or slash (/). The contents of an alphanumeric edited data item when represented in standard data format must be two or more characters in the character set of the computer. See the [examples](#) on page 58.

Numeric

Its PICTURE character-string can contain only the symbols **9**, **P**, **S**, and **V**. Its PICTURE character-string must contain at least one symbol **9** and not more than thirty symbols **9**. Each symbol **9** specifies a digit position. If unsigned, the contents of a numeric data item when

represented in standard data format must be one or more numeric characters. If signed, a numeric data item may also contain a "+", "-", or other representation of an operational sign. The actual in-memory contents of a numeric data item are not standard data format when the usage is other than DISPLAY as specified by a USAGE clause that applies to the data description entry or when the data item is signed, but without the SEPARATE CHARACTER phrase in a SIGN clause that applies to the data description entry. See the [examples](#) on page 59.

Numeric edited

Its PICTURE character-string is restricted to certain combinations of the following symbols: **B**, slash (/), **P**, **V**, **Z**, **0**, **9**, comma (,), period (.), asterisk (*), minus (-), plus (+), **CR**, **DB**, and the currency symbol (the symbol \$ or the symbol specified in the CURRENCY SIGN clause of the SPECIAL-NAMES paragraph). The allowable combinations are determined from the order of precedence of symbols and the editing rules. The number of digit positions that can be represented in the PICTURE character-string must range from one to thirty, inclusive. The character-string must contain at least one symbol **0**, **B**, slash, **Z**, asterisk, plus, minus, comma, period, **CR**, **DB**, or the currency symbol. The contents of each of the character positions in a numeric edited data item must be consistent with the corresponding PICTURE symbol. See the [examples](#) on page 59.

Alphabetic PICTURE Character-String Examples

```
A           *> 1-character alphabetic item
AAAAA      *> 5-character alphabetic item
A(5)       *> 5-character alphabetic item
AAAA(4)A   *> 8-character alphabetic item
```

Alphanumeric PICTURE Character-String Examples

```
X           *> 1-character alphanumeric item
A9          *> 2-character alphanumeric item
AX9        *> 3-character alphanumeric item
X(5)       *> 5-character alphanumeric item
XXX9(4)A   *> 8-character alphanumeric item
X(80)      *> 80-character alphanumeric item
```

Alphanumeric-Edited PICTURE Character-String Examples

```
XX/BB/00   *> 8-character alphanumeric edited item
XX/990/0BB *> 10-character alphanumeric edited item
X(4)BA(4)B9(4) *> 14-character alphanumeric edited item
```

Numeric PICTURE Character-String Examples

```
*> Unsigned integers:
9          1-digit numeric integer (1,0)
99         2-digit numeric integer (2,0)
9(6)       6-digit numeric integer (6,0)
9(30)      30-digit numeric integer (30,0)
9(6)V      6-digit numeric integer (6,0)
9(6)PPV    6-digit numeric integer (2 right scaling)
9(8)P(4)   8-digit numeric integer (4 right scaling)

*> Unsigned non-integer numbers:
V9         1-digit numeric fraction (1,1)
VPPP9(4)   4-digit numeric fraction (4,6)
P(6)9(2)   2-digit numeric fraction (2,8)
9(4)V9(5)  9-digit numeric (9,5)

*> Signed integers:
S9         1-digit numeric integer (1,0)
S99        2-digit numeric integer (2,0)
S9(6)      6-digit numeric integer (6,0)
S9(30)     30-digit numeric integer (30,0)
S9(6)V     6-digit numeric integer (6,0)
S9(6)PPV   6-digit numeric integer (2 right scaling)
S9(8)P(4)  8-digit numeric integer (4 right scaling)

*> Signed non-integer numbers:
SV9        1-digit numeric fraction (1,1)
SVPPP9(4)  4-digit numeric fraction (4,6)
SP(6)9(2)  2-digit numeric fraction (2,8)
S9(4)V9(5) 9-digit numeric (9,5)
```

Numeric-Edited PICTURE Character-String Examples

```
*> Simple insertion editing (comma, space (B), zero, slash):
999,999,999 *> 9-digit (size 11) numeric edited item (9,0)
99,999BB    *> 5-digit (size 8) numeric edited item (5,0)
99/00/99    *> 4-digit (size 8) numeric edited item (4,0)

*> Special insertion editing (explicit decimal point):
9(5).99     *> 7-digit (size 8) numeric edited item (7,2)
999,999.99  *> 8-digit (size 10) numeric edited item (8,2)
9,999.9999  *> 8-digit (size 10) numeric edited item (8,4)

*> Fixed insertion editing (sign or currency):
9(5)CR      *> 5-digit (size 7) numeric edited item (5,0)
99DB        *> 2-digit (size 4) numeric edited item (2,0)
9(5)+       *> 5-digit (size 6) numeric edited item (5,0)
999.99-     *> 5-digit (size 7) numeric edited item (5,2)
+9(18)      *> 18-digit (size 19) numeric edited item (18,0)
-9(6)V99    *> 8-digit (size 9) numeric edited item (8,2)
$9(4).99    *> 6-digit (size 10) numeric edited item (6,2)

*> Floating insertion editing (sign or currency):
```

```

+++9          *> 3-digit (size 4) numeric edited item (3,0)
-(8)9        *> 8-digit (size 9) numeric edited item (8,0)
-(3).-(4)    *> 6-digit (size 8) numeric edited item (6,4)
$(5)9        *> 5-digit (size 6) numeric edited item (5,0)
$(6)         *> 5-digit (size 6) numeric edited item (5,0)

*> Zero suppression editing (spaces (Z) or asterisk (*)):
Z(5)         *> 5-digit (size 5) numeric edited item (5,0)
Z(5)9        *> 6-digit (size 6) numeric edited item (6,0)
Z(5).ZZ      *> 7-digit (size 8) numeric edited item (7,2)
ZZZ,ZZZ,ZZ9 *> 9-digit (size 11) numeric edited item (9,0)
*(5)         *> 5-digit (size 5) numeric edited item (5,0)
***9.99      *> 6-digit (size 7) numeric edited item (6,2)
***,**9.99   *> 8-digit (size 10) numeric edited item (8,2)
*(5).**       *> 7-digit (size 8) numeric edited item (7,2)

```

PICTURE Symbols

The functions of the symbols used in a PICTURE character-string to describe an elementary data item are as follows:

PICTURE Symbol	Description
A	Each symbol A in the character-string represents a character position that can contain only an alphabetic character ("a" through "z", "A" through "Z", and space). Each symbol A is counted in the size of the data item described by the PICTURE character-string.
B	Each symbol B in the character-string represents a character position into which the character space will be inserted when the data item is the receiving item of an elementary MOVE statement. Each symbol B is counted in the size of the data item described by the PICTURE character-string.
P	Each symbol P in the character-string indicates an assumed decimal scaling position and is used to specify the location of an assumed decimal point when the point is not within the number that appears in the data item. The scaling position symbol P is not counted in the size of the data item described by the PICTURE character-string, but each symbol P is counted in determining the maximum number (30) of digit positions in numeric and numeric edited data items. The symbol P may appear only as a contiguous string in the leftmost or rightmost digit positions within a PICTURE character-string. Since the scaling position symbol P implies an assumed decimal point (to the left of the symbols P if they are the leftmost digit positions and to the right of the symbols P if they are the rightmost digit positions), the assumed decimal point symbol V is redundant either to the left or right of the symbols P , respectively, within such a PICTURE character-string. The symbol P and the insertion symbol period (.) cannot both occur in the same PICTURE character-string.

PICTURE Symbol	Description
S	The symbol S is used in the character-string to indicate the presence, but neither the representation nor, necessarily, the position of an operational sign. The symbol S must be written as the leftmost character in the PICTURE character-string. The symbol S is not counted in determining the size (in terms of standard data format characters) of the data item described by the PICTURE character-string unless the entry contains or is subject to a SIGN clause that specifies the SEPARATE CHARACTER phrase. The symbol S in the PICTURE character-string and the BLANK WHEN ZERO clause may not occur in the same data description entry.
V	The symbol V is used in a character-string to indicate the location of the assumed decimal point and may appear only once in any single PICTURE character-string. The symbol V does not represent a character position and therefore is not counted in the size of the data item described by the PICTURE character-string. When the assumed decimal point is to the right of the rightmost symbol in the string representing a digit position or scaling position or is to the left of scaling positions that represent the leftmost digit positions, the symbol V is redundant. The symbol V and the insertion symbol period (.) cannot both occur in the same PICTURE character-string.
X	Each symbol X in the character-string is used to represent a character position that contains any allowable character from the character set of the computer. Each symbol X is counted in the size of the data item described by the PICTURE character-string.
Z	Each symbol Z in a character-string may only be used to represent the leftmost leading numeric character positions that will be replaced by space characters when the contents of those character positions are leading zeroes and the data item is the receiving item of an elementary MOVE statement. Each symbol Z is counted in the size of the item described by the PICTURE character-string and in determining the maximum number (30) of digit positions allowed in a numeric edited data item. If the symbol Z is used to the right of the decimal point in a character-string, then all digit positions in that character-string must be described with the symbol Z . If the symbol Z represents all the digit-positions in the character-string, then the described data item is blank when zero, even if the BLANK WHEN ZERO clause is not specified.
9	Each symbol 9 in the character-string represents a character position that contains a numeric character. Each symbol 9 is counted in the size of the item described by the PICTURE character-string and in determining the maximum number (30) of digit positions in a numeric or numeric edited data item.
0	Each symbol 0 in the character-string represents a character position into which the character zero ("0") will be inserted when the data item is the receiving item of an elementary MOVE statement and removed when a numeric edited data item is the sending item in an elementary MOVE statement with a numeric or numeric edited receiving data item. Each symbol 0 is counted in the size of the data item described by the PICTURE character-string. The symbol 0 does not represent a digit position in a numeric edited data item.
/	Each symbol slash (/) in the character-string represents a character position into which a character slash ("/") will be inserted when the data item is the receiving item of an elementary MOVE statement. Each symbol slash (/) is counted in the size of the data item described by the PICTURE character-string.

PICTURE Symbol	Description
,	Each symbol comma (,) in the character-string represents a character position into which a character comma (",") will be inserted when the data item is the receiving item of an elementary MOVE statement. Each symbol comma (,) is counted in the size of the data item described by the PICTURE character-string.
.	When the symbol period (.) appears in the character-string it is an editing symbol that represents the decimal point for alignment purposes and, in addition, represents a character position into which the character period (".") will be inserted. The symbol period is counted in the size of the data item described by the PICTURE character-string. The symbols P and V cannot occur with a symbol period (.) in the same PICTURE character-string. Note For a given program the functions of the period and comma are exchanged if the DECIMAL-POINT IS COMMA clause is stated in the SPECIAL-NAMES paragraph. In this exchange the rules for the period apply to the comma and the rules for the comma apply to the period wherever they appear in a PICTURE character-string.
+, -, CR, DB	These symbols are used as editing sign control symbols. When used, they represent the character position into which the editing sign control symbol will be placed. The symbols are mutually exclusive in any one PICTURE character-string and each character used in the symbol is counted in determining the size of the data item described by the PICTURE character-string. If the symbols plus or minus occur more than once (a floating sign control symbol), then one less than the total number of these symbols is counted in determining the maximum number (30) of digit positions allowed in a numeric edited data item. If a floating symbol plus or minus is used to the right of the decimal point in a character-string, then all digit positions in that character-string must be described with the symbol plus or minus, respectively. If a floating plus or minus symbol string represents all the digit-positions in the character-string, then the described data item is blank when zero, even if the BLANK WHEN ZERO clause is not specified.
*	Each symbol asterisk (*) in the character-string represents a leading numeric character position into which a character asterisk ("*") will be placed when that position contains a leading zero and the data item is the receiving item of an elementary MOVE statement. Each symbol asterisk (*) is counted in the size of the data item described by the PICTURE character-string and in determining the maximum number (30) of digit positions allowed in a numeric edited data item. If the symbol asterisk (*) is used to the right of the decimal point in a character-string, then all digit positions in that character-string must be described with the symbol asterisk (*). The symbol asterisk in the PICTURE character-string and the BLANK WHEN ZERO clause may not occur in the same data description entry. If the symbol asterisk represents all the digit-positions in the character-string, then, when zero, the described data item is all asterisks (ALL "*"), except that, if the character-string contains the symbol period (.), a period (".") will occur at the specified location in the data item.

PICTURE Symbol	Description
cs	The currency symbol in a character-string is represented by either the currency sign (the symbol \$) or by the single character specified in the CURRENCY SIGN clause in the SPECIAL-NAMES paragraph. The currency symbol in the character-string represents a character position into which a currency symbol is to be placed when the data item is the receiving item of an elementary MOVE statement. Each currency symbol is counted in the size of the data item described by the PICTURE character-string. If the currency symbol occurs more than once (a floating currency symbol), then one less than the total number of currency symbols is counted in determining the maximum number (30) of digit positions allowed in a numeric edited data item. If the currency symbol is used to the right of the decimal point in a character-string, then all digit positions in that character-string must be described with the currency symbol. If a floating currency symbol string represents all the digit-positions in the character-string, then the described data item is blank when zero, even if the BLANK WHEN ZERO clause is not specified.

LIKE Pattern Grammar

The grammar for a regular expression that specifies the pattern for a LIKE condition is as follows:

[1] regExp	::= branch (' ' branch) *
[2] branch	::= piece*
[3] piece	::= atom quantifier?
[4] quantifier	::= [?*+] ('{' quantity '}')
[5] quantity	::= quantRange quantMin QuantExact
[6] quantRange	::= QuantExact ',' QuantExact
[7] quantMin	::= QuantExact ','
[8] QuantExact	::= [0-9]+
[9] atom	::= Char charClass ('(' regExp ')')
[10] Char	::= [^\.?*+() #x5B#x5D]
[11] charClass	::= charClassEsc charClassExpr
[12] charClassExpr	::= '[' charGroup ']'

- [13] charGroup ::= posCharGroup | negCharGroup | charClassSub
- [14] posCharGroup ::= (charRange | charClassEsc)+
- [15] negCharGroup ::= '^' posCharGroup
- [16] charClassSub ::= (posCharGroupND | negCharGroupND)
 '-' charClassExpr
- [17] negCharGroupND ::= '^' posCharGroupND
- [18] posCharGroupND ::= (XmlCharRef | XmlChar | charClassEsc)+
- [19] XmlCharRef ::= ('&#' [0-9]+ ';') |
 ('&#x' [0-9a-fA-F]+ ';')
- [20] XmlChar ::= [^\#x2D#x5B#x5D]
- [21] charRange ::= seRange | XmlCharRef | XmlCharIncDash
- [22] seRange ::= charOrEsc '-' charOrEsc
- [23] charOrEsc ::= XmlChar | SingleCharEsc
- [24] XmlCharIncDash ::= [^\#x5B#x5D]
- [25] charClassEsc ::= (SingleCharEsc | MultiCharEsc |
 catEsc | complEsc)
- [26] SingleCharEsc ::= '\' [nrt\|.?*+(){}#x2D#x5B#x5D#x5E]
- [27] catEsc ::= '\p{' charProp '}'
- [28] complEsc ::= '\P{' charProp '}'
- [29] charProp ::= IsCategory | IsBlock
- [30] IsCategory ::= Letters | Marks | Numbers |
 Punctuation | Separators |
 Symbols | Others
- [31] Letters ::= 'L' [ultmo]?
- [32] Marks ::= 'M' [nce]?
- [33] Numbers ::= 'N' [dlo]?

- [34] Punctuation ::= 'P' [cdseifo]?
- [35] Separators ::= 'Z' [slp]?
- [36] Symbols ::= 'S' [mcko]?
- [37] Others ::= 'C' [cfon]?
- [38] IsBlock ::= 'Is' [a-zA-Z [0-9a-zA-Z#x2D]]*
- [39] MultiCharEsc ::= '.' | ('\ ' [sSiIcCdDwW])

Note that in the grammar, quoted characters, for example '|', in a rule indicate that the literal character itself may appear in a regular expression derived from the rule.

In the grammar, certain unquoted characters have special meaning as follows:

- * zero or more occurrences are allowed (Kleene closure)
- + one or more occurrences are allowed (positive closure)
- ? zero or no occurrences are allowed (optional)
- [] any of the class of characters contained between the brackets. A hyphen is used to represent a range of characters, unless the hyphen is the first or last character in the class, in which case it represents a hyphen character in the class.
- [^] any character other than the class of characters between the brackets and following the ^.
For example, [^0-9] means any character other than a decimal digit.

Note These characters have similar meaning when used in an actual pattern regular expression, but their use in the grammar is distinct from their occurrence in a pattern. For example, grammar rule 4 shows that the ?, *, and + characters may be used in a pattern by giving the grammar class expression [?*+].

In the grammar, some characters are represented by the hexadecimal representation #xhh, where hh specifies the two hexadecimal digits for the code-point of the desired character.

Here are some examples of patterns that may be used for a LIKE condition.

Pattern	Meaning
Box	The string "Box".
\s*(dog cat)\s*	Zero or more white space characters followed by the string "dog" or the string "cat" followed by zero or more white space characters.
([Cc]at [Tt]ext) box	The strings "Cat box", "cat box", "Text box", or "text box".
[0-9]+\.[0-9]{1,5}	One or more decimal digits followed by a decimal point followed by 1 to 5 decimal digits.
\d+\.\d+\D*	One or more decimal digits followed by a decimal point followed by one or more decimal digits followed by zero or more characters other than decimal digits.

Pattern	Meaning
<code>\d{1,3}(\,d{3})*\.\d+</code>	One to three decimal digits followed by zero or more occurrences of three decimal digits with a leading comma followed by a decimal point followed by one or more decimal digits.
<code>.*Butter.*</code>	Zero or more of any character followed by the string "Butter" followed by zero or more of any character.
<code>(cat)?box</code>	The string "cat box" or the string "box".
<code>\p{Ll}{3,}</code>	Three or more lower-case letter characters.
<code>.*[\p{Lu}-[M-P]]+</code>	Zero or more of any character followed by one or more of any character in the class of upper-case letters excluding M, N, O, and P.

The following quantifier equivalences occur in a regular expression.

Short Quantifier	Equivalent Quantifier	Meaning
<code>?</code>	<code>{0,1}</code>	Zero or one (optional)
<code>*</code>	<code>{0,}</code>	Zero or more (Kleene closure)
<code>+</code>	<code>{1,}</code>	One or more (positive closure)

The following XML entity references are recognized in a regular expression and converted to the corresponding character.

Entity Reference	Character	Description
<code>&amp;</code>	<code>&</code>	ampersand
<code>&apos;</code>	<code>'</code>	apostrophe
<code>&lt;</code>	<code><</code>	less than sign
<code>&gt;</code>	<code>></code>	greater than sign
<code>&quot;</code>	<code>"</code>	double quote

These XML entity references are recognized in addition to XML character references. XML character references specify a particular code-point with the forms `&#d`, where *d* is the decimal value of the code-point, or `&#xh`, where *h* is the hexadecimal value of the code-point, per rule 19 of the grammar.

The following escape sequences represent a single character in a regular expression.

Escape Sequence	Character
<code>\n</code>	newline (<code>&#x0A;</code>)
<code>\r</code>	return (<code>&#x0D;</code>)
<code>\t</code>	horizontal tab (<code>&#x09;</code>)
<code>\\</code>	<code>\</code>
<code>\\</code>	<code> </code>

Escape Sequence	Character
\\.	.
\\-	-
\\^	^
\\?	?
*	*
\\+	+
\\{	{
\\}	}
\\((
\\))
\\[[
\\]]

The following escape sequences represent multiple characters; that is, a character class, in a regular expression.

Escape Sequence	Equivalent Character Class	Meaning
.	[^\n\r]	Any character except newline or return.
\\s	[\t\n\r]	White space.
\\S	[^\s]	Not whitespace.
\\i	[p{L}_:]	Initial name characters (of XML).
\\I	[^i]	Not initial name characters (of XML).
\\c	[i\d\.·-]	Name characters (of XML). Note The B7h code point in Unicode is the “MIDDLE DOT” extender character and is classified as a name character. Therefore, XML name characters include this code point value.
\\C	[^c]	Not name characters (of XML).
\\d	\p{Nd}	Numeric digits.
\\D	[^d]	Not numeric digits.
\\w	[�-ÿ- [p{P}\p{Z}\p{S}\p{C}]]	All characters except punctuation, separator, symbol, and other characters.
\\W	[^w]	Punctuation, separator, symbol and other characters.

The following Unicode categories may be specified in a regular expression category escape by use of the indicated property designator.

Category	Property Designator	Character Class
Letters	L	All letters.
	Lu	Uppercase letters.
	Ll	Lowercase letters.
	Lt	Title case letters.
	Lm	Modifier letters.
	Lo	Other letters.
Marks	M	All marks.
	Mn	Non-spacing marks.
	Mc	Spacing combining marks.
	Me	Enclosing marks.
Numbers	N	All numbers.
	Nd	Decimal digit numbers.
	Nl	Letter numbers.
	No	Other numbers.
Punctuation	P	All punctuation.
	Pc	Connector punctuation.
	Pd	Dash punctuation.
	Ps	Open punctuation.
	Pe	Close punctuation.
	Pi	Initial quote punctuation.
	Pf	Final quote punctuation.
	Po	Other punctuation.
Separators	Z	All separators.
	Zs	Space separators.
	Zl	Line separators.
	Zp	Paragraph separators.
Symbols	S	All symbols.
	Sm	Math symbols.
	Sc	Currency symbols.
	Sk	Modifier symbols.
	So	Other symbols.
Other	C	All others.
	Cc	Control others.
	Cf	Format others.
	Co	Private use others.

Category	Property Designator	Character Class
	Cn	Not assigned others.

Directives

IMP MARGIN-R

>> IMP MARGIN-R IS AFTER $\left\{ \begin{array}{l} \{ \text{COLUMN} \} \\ \{ \text{COL} \} \\ \text{END OF RECORD} \end{array} \right\} \textit{integer-1}$

LISTING

>> LISTING $\left\{ \begin{array}{l} \text{ON} \\ \text{OFF} \end{array} \right\}$

PAGE

>> PAGE [*comment-text-1*]

Program Structure

General Format for Nested Source Programs

$\left\{ \begin{array}{l} \text{IDENTIFICATION} \\ \text{ID} \end{array} \right\} \text{DIVISION.}$

$\text{PROGRAM-ID.} \left\{ \begin{array}{l} \text{program-name-1} \\ \text{literal-1} \end{array} \right\} [\text{IS INITIAL PROGRAM}].$

$[\text{ENVIRONMENT DIVISION. } \textit{environment-division-content-1}]$

$[\text{DATA DIVISION. } \textit{data-division-content-1}]$

$[\text{PROCEDURE DIVISION. } \textit{procedure-division-content-1}]$

$[\textit{nested-source-program-1}] \dots$

$\text{END PROGRAM} \left[\begin{array}{l} \text{program-name-1} \\ \text{literal-1} \end{array} \right].$

General Format for *nested-source-program*

$\left\{ \begin{array}{l} \text{IDENTIFICATION} \\ \text{ID} \end{array} \right\} \text{DIVISION.}$

$\text{PROGRAM-ID.} \left\{ \begin{array}{l} \text{program-name-2} \\ \text{literal-2} \end{array} \right\} \left[\text{IS} \left\{ \begin{array}{l} \text{COMMON} \\ \text{INITIAL} \end{array} \right\} \text{PROGRAM} \right].$

$[\text{ENVIRONMENT DIVISION. } \textit{environment-division-content-2}]$

$[\text{DATA DIVISION. } \textit{data-division-content-2}]$

$[\text{PROCEDURE DIVISION. } \textit{procedure-division-content-2}]$

$[\textit{nested-source-program-2}] \dots$

$\text{END PROGRAM} \left[\begin{array}{l} \text{program-name-2} \\ \text{literal-2} \end{array} \right].$

General Format for a Sequence of Source Programs

$$\left\{ \left\{ \begin{array}{l} \text{IDENTIFICATION} \\ \text{ID} \end{array} \right\} \text{DIVISION.} \right.$$

$$\text{PROGRAM-ID. } \left\{ \begin{array}{l} \text{program-name-3} \\ \text{literal-3} \end{array} \right\} [\text{IS INITIAL PROGRAM}].$$

$$[\text{ENVIRONMENT DIVISION. } \textit{environment-division-content-3}]$$

$$[\text{DATA DIVISION. } \textit{data-division-content-3}]$$

$$[\text{PROCEDURE DIVISION. } \textit{procedure-division-content-3}]$$

$$[\textit{nested-source-program-3}] \dots$$

$$\text{END PROGRAM } \left\{ \begin{array}{l} \text{program-name-3} \\ \text{literal-3} \end{array} \right\} . \left. \dots \right\}$$

$$\left\{ \left\{ \begin{array}{l} \text{IDENTIFICATION} \\ \text{ID} \end{array} \right\} \text{DIVISION.} \right.$$

$$\text{PROGRAM-ID. } \left\{ \begin{array}{l} \text{program-name-4} \\ \text{literal-4} \end{array} \right\} [\text{IS INITIAL PROGRAM}].$$

$$[\text{ENVIRONMENT DIVISION. } \textit{environment-division-content-4}]$$

$$[\text{DATA DIVISION. } \textit{data-division-content-4}]$$

$$[\text{PROCEDURE DIVISION. } \textit{procedure-division-content-4}]$$

$$\left[[\textit{nested-source-program-4}] \dots \right.$$

$$\left. \left[\text{END PROGRAM } \left[\begin{array}{l} \text{program-name-4} \\ \text{literal-4} \end{array} \right] \right] . \right]$$

COBOL Words

The reserved words are divided into the following alphabetical groups:

- [Reserved Words \(A - B\)](#) on page 72
- [Reserved Words \(C\)](#) on page 72
- [Reserved Words \(D\)](#) on page 73
- [Reserved Words \(E\)](#) on page 73
- [Reserved Words \(F - I\)](#) on page 74
- [Reserved Words \(J - N\)](#) on page 75

- [Reserved Words \(O - Q\)](#) on page 75
- [Reserved Words \(R\)](#) on page 76
- [Reserved Words \(S\)](#) on page 76
- [Reserved Words \(T - Z\)](#) on page 77

† *This word is not considered reserved if the RM/COBOL (74) 2.0 compatibility option is present in the [Compile Command](#) on page 1. In such cases, this word is treated as a user-defined word whenever it occurs in the source program. For further information, see Chapter 6: Compiling, in the RM/COBOL User's Guide.*

Reserved Words (A - B)

Reserved Words (A - B)		
ACCEPT	ALPHANUMERIC-EDITED †	AT
ACCESS	ALSO †	AUTHOR
ADD	ALTER	
ADDRESS †	ALTERNATE	BEEP
ADVANCING	AND	BEFORE
AFTER	ANY †	BELL †
ALL	ARE	BINARY
ALPHABET †	AREA	BLANK
ALPHABETIC	AREAS	BLINK
ALPHABETIC-LOWER †	AS †	BLOCK
ALPHABETIC-UPPER †	ASCENDING †	BOTTOM †
ALPHANUMERIC †	ASSIGN	BY

Reserved Words (C)

Reserved Words (C)		
CALL	COLUMN †	CONFIGURATION
CANCEL	COMMA	CONTAINS
CD †	COMMON †	CONTENT †
CENTURY-DATE †	COMMUNICATION †	CONTINUE †
CENTURY-DAY †	COMP	CONTROL †
CF †	COMP-1	CONTROLS †
CH †	COMP-3	CONVERT

Reserved Words (C)

CHARACTER	COMP-4 †	CONVERTING †
CHARACTERS	COMP-5 †	COPY
CLASS †	COMP-6	CORR
CLOCK-UNITS †	COMPUTATIONAL	CORRESPONDING
CLOSE	COMPUTATIONAL-1	COUNT †
COBOL †	COMPUTATIONAL-3	COUNT-MAX †
CODE †	COMPUTATIONAL-4 †	COUNT-MIN †
CODE-SET	COMPUTATIONAL-5 †	CURRENCY
COL †	COMPUTATIONAL-6	CURSOR †
COLLATING	COMPUTE	

Reserved Words (D)

Reserved Words (D)

DATA	DEBUG-LINE †	DEPENDING
DATA-POINTER †	DEBUG-NAME †	DESCENDING †
DATE	DEBUG-SUB-1 †	DESTINATION †
DATE-AND-TIME †	DEBUG-SUB-2 †	DETAIL †
DATE-COMPILED †	DEBUG-SUB-3 †	DISABLE †
DATE-WRITTEN	DEBUGGING †	DISPLAY
DAY	DECIMAL-POINT	DIVIDE
DAY-AND-TIME †	DECLARATIVES	DIVISION
DAY-OF-WEEK †	DEFAULT †	DOWN
DE †	DELETE	DUPLICATES
DEBUG-CONTENTS †	DELIMITED †	DYNAMIC
DEBUG-ITEM †	DELIMITER †	

Reserved Words (E)

Reserved Words (E)

ECHO	END-MULTIPLY †	ENVIRONMENT
EGI †	END-OF-PAGE †	EOP †
ELSE	END-PERFORM †	EQUAL

EMI †	END-READ †	ERASE
ENABLE †	END-RECEIVE †	ERROR
END	END-RETURN †	ESCAPE †
END-ACCEPT †	END-REWRITE †	ESI †
END-ADD †	END-SEARCH †	EVALUATE †
END-CALL †	END-START †	EVERY †
END-COMPUTE †	END-STRING †	EXCEPTION
END-DELETE †	END-SUBTRACT †	EXCLUSIVE †
END-DIVIDE †	END-UNSTRING †	EXIT
END-EVALUATE †	END-WRITE †	EXTEND
END-IF †	ENTER †	EXTERNAL †

Reserved Words (F - I)

Reserved Words (F - I)

FALSE †	GOBACK †	IN
FD	GREATER	INDEX
FILE	GROUP †	INDEXED
FILE-CONTROL		INDICATE †
FILLER	HEADING †	INITIAL
FINAL †	HIGH	INITIAL-VALUE †
FIRST	HIGH-VALUE	INITIALIZE †
FIXED †	HIGH-VALUES	INITIATE †
FOOTING †	HIGHEST-VALUE	INPUT
FOR	HIGHLIGHT †	INPUT-OUTPUT
FROM		INSPECT
FUNCTION †	I-O	INSTALLATION
	I-O-CONTROL	INTO
GENERATE †	ID †	INVALID
GIVING	IDENTIFICATION	IS
GLOBAL †	IF	
GO	IMP †	

Reserved Words (J - N)

Reserved Words (J - N)		
JUST	LINE	MODE
JUSTIFIED	LINE-COUNTER †	MODULES
	LINES	MOVE
KEY	LINKAGE	MULTIPLY
	LOCK	
LABEL	LOW	NATIVE
LAST †	LOW-VALUE	NEGATIVE †
LEADING	LOW-VALUES	NEXT
LEFT	LOWEST-VALUE	NO
LENGTH †	LOWLIGHT †	NOT
LESS		NULL †
LIKE †	MAX-VALUE †	NULLS †
LIMIT †	MEMORY	NUMBER †
LIMITS †	MERGE †	NUMERIC
LINAGE †	MESSAGE †	NUMERIC-EDITED †
LINAGE-COUNTER †	MIN-VALUE †	

Reserved Words (O - Q)

Reserved Words (O - Q)		
OBJECT-COMPUTER	PACKED-DECIMAL †	PROCEDURE
OCCURS	PADDING †	PROCEDURE-NAME †
OF	PAGE	PROCEDURES †
OFF	PAGE-COUNTER †	PROCEED
OMITTED	PERFORM	PROGRAM
ON	PF †	PROGRAM-ID
OPEN	PH †	PROMPT
OPTIONAL †	PIC	PURGE †
OR	PICTURE	
ORDER †	PLUS †	QUEUE †
ORGANIZATION	POINTER †	QUOTE
OTHER †	POSITION	QUOTES

Reserved Words (O - Q)

OUTPUT	POSITIVE †
OVERFLOW	PRINTING †

Reserved Words (R)

Reserved Words (R)

RANDOM	REMAINDER	RETURN-CODE †
RD †	REMARKS †	RETURNING †
READ	REMOVAL †	REVERSE
RECEIVE †	RENAMES	REVERSE-VIDEO †
RECORD	REPLACE †	REVERSED †
RECORDING †	REPLACING	REWIND
RECORDS	REPORT †	REWRITE
REDEFINES	REPORTING †	RF †
REEL	REPORTS †	RH †
REFERENCE †	RERUN †	RIGHT
REFERENCES †	RESERVE	ROUNDED
RELATIVE	RESET †	RUN
RELEASE †	RETURN †	

Reserved Words (S)

Reserved Words (S)

SAME	SEQUENTIAL	START
SCREEN †	SET	STATUS
SD †	SIGN	STOP
SEARCH †	SIZE	STRING †
SECTION	SORT †	SUB-QUEUE-1 †
SECURE †	SORT-MERGE †	SUB-QUEUE-2 †
SECURITY	SOURCE †	SUB-QUEUE-3 †
SEGMENT †	SOURCE-COMPUTER	SUBTRACT
SEGMENT-LIMIT †	SPACE	SUM †
SELECT	SPACES	SUPPRESS †

Reserved Words (S)

SEND †	SPECIAL-NAMES	SYMBOLIC †
SENTENCE	STANDARD	SYNC
SEPARATE	STANDARD-1	SYNCHRONIZED
SEQUENCE	STANDARD-2 †	

Reserved Words (T - Z)

Reserved Words (T - Z)

TAB	TOP †	VALUE
TABLE †	TRAILING	VALUES
TALLYING	TRUE †	VARIABLE †
TAPE †	TYPE †	VARYING
TERMINAL †		
TERMINATE †	UNIT	WHEN
TEST †	UNLOCK	WHEN-COMPILED †
TEXT †	UNSTRING †	WITH
THAN	UNTIL	WORDS
THEN †	UP	WORKING-STORAGE
THROUGH	UPDATE	WRITE
THRU	UPON †	
TIME	USAGE	ZERO
TIMES	USE	ZEROES
TO	USING	ZEROS

Unused Reserved Words

RM/COBOL reserves several words that do not currently appear in any format. These words are reserved because they are reserved words in ANSI COBOL within an optional module not supported by RM/COBOL or within another dialect of COBOL. The ANSI COBOL optional modules not supported by RM/COBOL include the Debug Module, the Intrinsic Function Module, and the Report Writer Module. Note that the Debug Module was stated to be obsolete in the 1985 ANSI COBOL Standard, which means it is to be removed from the next revision of ANSI COBOL.

The unused reserved words are as follows:

CF; CH; CODE; CONTROLS; DE; DEBUG-CONTENTS; DEBUG-ITEM; DEBUG-LINE;
DEBUG-NAME; DEBUG-SUB-1; DEBUG-SUB-2; DEBUG-SUB-3; DETAIL; FINAL;
FIXED; FUNCTION; GENERATE; GROUP; HEADING; INDICATE; INITIATE; LIMIT;

LIMITS; LINE-COUNTER; PAGE-COUNTER; PF; PH; PROCEDURES; RD;
RECORDING; REFERENCES; REPORT; REPORTING; REPORTS; RESET; RF; RH;
SUM; TERMINATE; TYPE; VARIABLE

Context-Sensitive Words

A context-sensitive word is a COBOL word that is reserved only in the context of the general formats in which it is specified. In other contexts, the word can be used as a user-defined word, for example, as a user-defined data-name.

Context-sensitive words and the contexts in which they are reserved are specified in the following table.

- † *This word is not considered reserved if the RM/COBOL (74) 2.0 compatibility option is present in the [Compile Command](#) on page 1. In such cases, this word is treated as a user-defined word whenever it occurs in the source program. For further information, see Chapter 6: Compiling, in the RM/COBOL User's Guide.*

Context-Sensitive Word	Language Construct or Context
AUTO †	Screen description entry (for AUTO clause) Format 3 (Terminal I-O) ACCEPT statement (for AUTO phrase)
AUTO-SKIP †	Screen description entry (for AUTO-SKIP clause) Format 3 (Terminal I-O) ACCEPT statement (for AUTO-SKIP phrase)
AUTOMATIC †	LOCK MODE clause in file control entry
BACKGROUND †	Screen description entry (for BACKGROUND clause)
BACKGROUND-COLOR †	Screen description entry (for BACKGROUND-COLOR clause)
CARD-PUNCH	ASSIGN clause (<i>device-name</i>) in file control entry
CARD-READER	ASSIGN clause (<i>device-name</i>) in file control entry
CASE-INSENSITIVE †	LIKE relational operator in LIKE relation condition
CASE-SENSITIVE †	LIKE relational operator in LIKE relation condition
CASSETTE	ASSIGN clause (<i>device-name</i>) in file control entry
CONSOLE	ASSIGN clause (<i>device-name</i>) in file control entry Special-Names paragraph (for CONSOLE IS <i>mnemonic-name</i> and CONSOLE IS CRT clauses)
CRT †	Special-Names paragraph (for CONSOLE IS CRT and CRT STATUS clauses)
CYCLE †	Format 3 EXIT statement
DISC	ASSIGN (<i>device-name</i>) clause in file control entry
DISK	ASSIGN (<i>device-name</i>) clause in file control entry
END-COPY †	COPY statement

Context-Sensitive Word	Language Construct or Context
END-REPLACE †	REPLACE statement
EOL	ERASE clause in screen description entry ERASE phrase in ACCEPT and DISPLAY statements
EOS	ERASE clause in screen description entry ERASE phrase in ACCEPT and DISPLAY statements
FOREGROUND †	Screen description entry (for FOREGROUND clause)
FOREGROUND-COLOR †	Screen description entry (for FOREGROUND-COLOR clause)
FULL †	Screen description entry (for FULL clause)
IMP †	Compiler directive (for implementor-defined directive)
KEYBOARD	ASSIGN clause (<i>device-name</i>) in file control entry
LISTING	ASSIGN clause (<i>device-name</i>) in file control entry Compiler directive (for LISTING directive)
MAGNETIC-TAPE	ASSIGN clause (<i>device-name</i>) in file control entry
MANUAL †	LOCK MODE clause in file control entry
MARGIN-R †	IMP compiler directive (for implementor-defined MARGIN-R directive)
MULTIPLE †	LOCK MODE clause in file control entry I-O-CONTROL paragraph (for MULTIPLE FILE TAPE clause)
PARAGRAPH †	Format 4 EXIT statement PROCEDURE-NAME special register
PREVIOUS †	Format 1 READ statement
PRINT	ASSIGN clause (<i>device-name</i>) in file control entry
PRINTER	ASSIGN clause (<i>device-name</i>) in file control entry
PRINTER-1	ASSIGN clause (<i>device-name</i>) in file control entry
REQUIRED †	Screen description entry (for REQUIRED clause)
SORT-WORK	ASSIGN clause (<i>device-name</i>) in file control entry
TRIMMED †	LIKE relational operator in LIKE relation condition
UNDERLINE †	Screen description entry (for UNDERLINE clause)
WHILE †	START statement (for WHILE phrase)
YYYYDDD †	FROM DAY phrase in ACCEPT statement (Format 2)
YYYYMMDD †	FROM DATE phrase in ACCEPT statement (Format 2)

Nonreserved System-Names

Code-Name

EBCDIC

(Color-Integer) Color-Names

(0)	BLACK
(1)	BLUE
(2)	GREEN
(3)	CYAN
(4)	RED
(5)	MAGENTA
(6)	BROWN
(7)	WHITE

Computer-Names

user-defined-word-1

Delimiter-Names

BINARY-SEQUENTIAL, LINE-SEQUENTIAL

Device-Names

CARD-PUNCH, CARD-READER, CASSETTE, CONSOLE, DISC, DISK, KEYBOARD,
LISTING, MAGNETIC-TAPE, PRINT, PRINTER, PRINTER-1, SORT-WORK

Feature-Names

C01, C02, C03, C04, C05, C06, C07, C08, C09, C10, C11, C12

Label-Names

FILE-ID
user-defined-word-2

Language-Names

user-defined-word-3

Low-Volume-I-O-Names

CONSOLE, SYSIN, SYSOUT

Rerun-Names

user-defined-word-4

Switch-Names

SWITCH-1, SWITCH-2, SWITCH-3, SWITCH-4, SWITCH-5, SWITCH-6, SWITCH-7,
SWITCH-8

UPSI-0, UPSI-1, UPSI-2, UPSI-3, UPSI-4, UPSI-5, UPSI-6, UPSI-7

RM/COBOL Language Examples

The examples in the following sections illustrate the RM/COBOL language syntax for the procedure division verbs. Some data division excerpts are shown to help understand statement syntax for the verb.

ACCEPT Statement Examples

ACCEPT Format 1

```
IDENTIFICATION DIVISION.  
PROGRAM-ID. ACCEPT01.  
*  
* Examples for RM/COBOL Language Reference Manual.  
* ACCEPT Format 1 statement.  
*  
ENVIRONMENT DIVISION.  
CONFIGURATION SECTION.  
SPECIAL-NAMES.  
    SYSIN IS input-terminal.  
DATA DIVISION.  
WORKING-STORAGE SECTION.  
01 NEXT-ITEM          PIC X(10).  
01 continuation-response PIC X(02).  
PROCEDURE DIVISION.  
0010.  
    ACCEPT NEXT-ITEM FROM CONSOLE.  
    ACCEPT continuation-response FROM input-terminal.  
  
END PROGRAM ACCEPT01.
```

ACCEPT Format 2

```
IDENTIFICATION DIVISION.  
PROGRAM-ID. ACCEPT02.  
*  
* Examples for RM/COBOL Language Reference Manual.  
* ACCEPT Format 2 statement.  
*
```

```
ENVIRONMENT DIVISION.
CONFIGURATION SECTION.
SPECIAL-NAMES.
    SYSIN IS input-terminal.
DATA DIVISION.
WORKING-STORAGE SECTION.
01 YEAR-DAY-VALUE          PIC 99/999.
01 YEAR-MONTH-DAY-VALUE   PIC 99/99/99.
01 TIME-VALUE             PIC 99/99/99/99.
01 CENTURY-DATE-VALUE     PIC 9999/99/99.
01 CENTURY-DAY-VALUE      PIC 9999/999.
01 DATE-AND-TIME-VALUE    PIC 9999/99/99BB99/99/99/99.
01 COMPILATION-DATE       PIC 9999/99/99.
01 DUMMY                  PIC X.
PROCEDURE DIVISION.
0010.
    ACCEPT YEAR-DAY-VALUE FROM DAY.
    ACCEPT YEAR-MONTH-DAY-VALUE FROM DATE.
    ACCEPT TIME-VALUE FROM TIME.
    ACCEPT CENTURY-DATE-VALUE FROM CENTURY-DATE.
    ACCEPT CENTURY-DATE-VALUE FROM DATE YYYYMMDD.
    ACCEPT CENTURY-DAY-VALUE FROM CENTURY-DAY.
    ACCEPT CENTURY-DAY-VALUE FROM DAY YYYYDDD.
    ACCEPT DATE-AND-TIME-VALUE FROM DATE-AND-TIME.
    ACCEPT COMPILATION-DATE FROM DATE-COMPILED.

    INSPECT TIME-VALUE REPLACING ALL "/" BY ":".
    INSPECT DATE-AND-TIME-VALUE REPLACING ALL "/" BY ":"
        AFTER INITIAL SPACE.

    DISPLAY "YEAR-DAY-VALUE = " YEAR-DAY-VALUE.
    DISPLAY "TIME-VALUE = " TIME-VALUE.
    DISPLAY "CENTURY-DAY-VALUE = " CENTURY-DAY-VALUE.
    DISPLAY "DATE-AND-TIME-VALUE = " DATE-AND-TIME-VALUE.
    DISPLAY "COMPILATION-DATE = " COMPILATION-DATE.

    ACCEPT DUMMY PROMPT.

END PROGRAM ACCEPT02.
```

ACCEPT Format 3

```
IDENTIFICATION DIVISION.
PROGRAM-ID. ACCEPT03.
*
* Examples for RM/COBOL Language Reference Manual.
* ACCEPT Format 3 statement.
*
DATA DIVISION.
WORKING-STORAGE SECTION.
01 ANSWER-1              PIC X(4).
01 ANSWER-2              PIC X(4).
01 START-VALUE           PIC S9(4)V99.
01 K                     PIC 9(2) BINARY.
01 NEXT-N                PIC 9(4).
01 DATE-G.
```

```

02 YEAR                PIC 9(4).
02 MONTH              PIC 9(2).
02 YR-LN              PIC 9(2) BINARY.
02 YR-POS             PIC 9(2) BINARY.
02 MN-LN              PIC 9(2) BINARY.
02 MN-POS             PIC 9(2) BINARY.
01 PASSWORD-VALUE     PIC X(10).
01 INVENTORY-COUNT    PIC 9(4).
01 FUNCTION-CODE      PIC 9(4).
01 command-string     PIC X(10).
01 command-line       PIC 9(02) BINARY.
01 command-column     PIC 9(02) BINARY.
01 command-cursor-offset PIC 9(02) BINARY.
01 command-control-string PIC X(50) VALUE "PROMPT, ECHO".
01 FIELD-G.
    02 FIELD-TABLE     OCCURS 10 INDEXED BY INX1.
        03 FIELD-DATA  PIC X(10).
        03 FIELD-LINE  PIC 9(2) BINARY.
        03 FIELD-COLUMN PIC 9(2) BINARY.
        03 FIELD-CONTROL PIC X(80).
01 DUMMY              PIC X.
PROCEDURE DIVISION.
0010.
    ACCEPT ANSWER-1, ANSWER-2.

    ACCEPT START-VALUE LINE 1, POSITION K,
        PROMPT, ECHO, CONVERT.

    ACCEPT NEXT-N POSITION 0, PROMPT, ECHO.

    ACCEPT YEAR, LINE YR-LN, POSITION YR-POS;
        MONTH, LINE MN-LN, POSITION MN-POS.

    ACCEPT PASSWORD-VALUE POSITION 0 OFF.

    ACCEPT INVENTORY-COUNT;
    ON EXCEPTION FUNCTION-CODE
        PERFORM FUNCTION-KEY-PROCEDURE
    END-ACCEPT.

    ACCEPT command-string
        LINE command-line
        COLUMN command-column
        CURSOR command-cursor-offset
        CONTROL command-control-string.

    ACCEPT FIELD-DATA (INX1) LINE FIELD-LINE (INX1)
        COL FIELD-COLUMN (INX1) CONTROL FIELD-CONTROL (INX1).

    ACCEPT DUMMY PROMPT.

FUNCTION-KEY-PROCEDURE.
    EXIT.

END PROGRAM ACCEPT03.

```

ACCEPT Format 4

```
IDENTIFICATION DIVISION.
PROGRAM-ID.  ACCEPT04.
*
*  Examples for RM/COBOL Language Reference Manual.
*  ACCEPT Format 4 statement.
*
DATA DIVISION.
WORKING-STORAGE SECTION.
01 DUMMY                                PIC X.
COMMUNICATION SECTION.
CD COM-LINE-1 FOR INPUT
    SYMBOLIC QUEUE IS L1-SYMQ
    SYMBOLIC SUB-QUEUE-1 IS L1-SYM-SUBQ1
    SYMBOLIC SUB-QUEUE-2 IS L1-SYM-SUBQ2
    SYMBOLIC SUB-QUEUE-3 IS L1-SYM-SUBQ3
    MESSAGE DATE IS L1-MSG-DT
    MESSAGE TIME IS L1-MSG-TM
    SYMBOLIC SOURCE IS L1-SYM-SRC
    TEXT LENGTH IS L1-TXT-LENGTH
    END KEY IS L1-END-KEY
    STATUS KEY IS L1-STATUS-KEY
    MESSAGE COUNT IS L1-MSG-COUNT.

PROCEDURE DIVISION.
0010.
    ACCEPT COM-LINE-1 MESSAGE COUNT.

    ACCEPT DUMMY PROMPT.

END PROGRAM ACCEPT04.
```

ACCEPT Format 5

```
IDENTIFICATION DIVISION.
PROGRAM-ID.  ACCEPT05.
*
*  Examples for RM/COBOL Language Reference Manual.
*  ACCEPT Format 5
*
DATA DIVISION.
WORKING-STORAGE SECTION.
01 WS-INV-DT                            PIC 9(8) VALUE 02031999.
01 WS-INV-AMT                            PIC S9(7) VALUE 0.
78 EMP-NAME-SIZE                          VALUE 30.
78 EMP-LOC-SIZE                           VALUE 15.
01 WS-EMP-NAME                            PIC X(EMP-NAME-SIZE) VALUE SPACES.
01 WS-EMP-LOC                             PIC X(EMP-LOC-SIZE) VALUE SPACES.
01 EOB-COL                                PIC 9(2) BINARY VALUE 10.
01 EOB-LINE                               PIC 9(2) BINARY VALUE 15.
01 ESCAPE-MESSAGE                         PIC X(20) VALUE "Escape key!".
SCREEN SECTION.
01 INVOICE-FORM.
    02 BLANK SCREEN.
```

```
02 "Invoice date: ".
02 INVOICE-DATE PIC 99/99/9999 FROM WS-INV-DT
    TO WS-INV-DT.
02 "Invoice amount: " LINE.
02 INVOICE-AMOUNT PIC 9(5).99CR USING WS-INV-AMT.
01 EMPLOYEE-RECORD.
02 BLANK SCREEN.
02 "Employee name: ".
02 ER-NAME          PIC X(EMP-NAME-SIZE) USING WS-EMP-NAME.
02 "Employee loc: " LINE.
02 ER-LOC          PIC X(EMP-LOC-SIZE) USING WS-EMP-LOC.
01 EOB-SCREEN.
02 ERASE.
02 "Explanation of Benefits Screen".
02 "Benefit amount: " LINE + 2 COL 10.
02 EOB-AMOUNT      PIC 9(5).99DB USING WS-INV-AMT.
```

```
PROCEDURE DIVISION.
A.
```

```
    DISPLAY INVOICE-FORM LINE 10 COLUMN 5.
    ACCEPT INVOICE-FORM AT LINE 10 COLUMN 5.
```

```
    DISPLAY EMPLOYEE-RECORD AT LINE 9.
    ACCEPT EMPLOYEE-RECORD LINE 9
    ON ESCAPE
        DISPLAY ESCAPE-MESSAGE LINE 23
    END-ACCEPT.
```

```
    DISPLAY EOB-SCREEN AT COL EOB-COL LINE EOB-LINE.
    ACCEPT EOB-SCREEN AT COL EOB-COL LINE EOB-LINE.
```

```
END PROGRAM ACCEPT05.
```

Add Statement Example

```
IDENTIFICATION DIVISION.
PROGRAM-ID.  ADD01.
*
*  Examples for RM/COBOL Language Reference Manual.
*  ADD statement.
*
DATA DIVISION.
WORKING-STORAGE SECTION.
01 SALARY          PIC 9(08)V99.
01 JOHNS-PAY      PIC 9(08)V99.
01 PAULS-PAY      PIC 9(08)V99.
01 ALBERTS-PAY    PIC 9(08)V99.
01 COMPANY-PAY    PIC 9(10)V99.
01 ACCUM-REC.
    02 DAY-TOTALS OCCURS 31 TIMES INDEXED BY DAYX.
        03 CATEGORY-A PIC 9(06) BINARY.
        03 CATEGORY-B PIC 9(06) BINARY.
        03 CATEGORY-C PIC 9(06) BINARY.
        03 CATEGORY-D PIC 9(06) BINARY.
```

Alter Statement Example
RM/COBOL Language Examples

```
02 MONTH-TOTALS      OCCURS 12 TIMES INDEXED BY MONTHX.
03 CATEGORY-A        PIC 9(06) BINARY.
03 CATEGORY-B        PIC 9(06) BINARY.
03 CATEGORY-C        PIC 9(06) BINARY.
03 CATEGORY-D        PIC 9(06) BINARY.
01 TOTAL-RECORD      PACKED-DECIMAL.
02 ENTERTAINMENT     PIC S9(06)V99.
02 GAS-AUTOMOTIVE    PIC S9(06)V99.
02 HOUSING           PIC S9(06)V99.
02 MEDICAL           PIC S9(06)V99.
02 RESTAURANT        PIC S9(06)V99.
02 SUPERMARKET       PIC S9(06)V99.
02 TRAVEL            PIC S9(06)V99.
01 SUB-TOTAL-RECORD  PACKED-DECIMAL.
02 ENTERTAINMENT     PIC S9(06)V99.
02 GAS-AUTOMOTIVE    PIC S9(06)V99.
02 HOUSING           PIC S9(06)V99.
02 MEDICAL           PIC S9(06)V99.
02 RESTAURANT        PIC S9(06)V99.
02 SUPERMARKET       PIC S9(06)V99.
02 TRAVEL            PIC S9(06)V99.
PROCEDURE DIVISION.
A.
  ADD SALARY TO SALARY.  *>(doubles the value of SALARY)

  ADD JOHNS-PAY, PAULS-PAY, ALBERTS-PAY
  GIVING COMPANY-PAY
  ON SIZE ERROR
  PERFORM BANKRUPTCY-PROC
  END-ADD.

  ADD CORRESPONDING
  DAY-TOTALS (DAYX) TO MONTH-TOTALS (MONTHX) .

  ADD CORR SUB-TOTAL-RECORD TO TOTAL-RECORD ROUNDED
  ON SIZE ERROR GO TO ERROR-ROUTINE
  NOT ON SIZE ERROR PERFORM AUDIT-ROUTINE
  END-ADD.

AUDIT-ROUTINE.
  EXIT.

ERROR-ROUTINE.
  EXIT.

BANKRUPTCY-PROC.
  EXIT.

END PROGRAM ADD01.
```

Alter Statement Example

```
IDENTIFICATION DIVISION.
PROGRAM-ID.  ALTER01.
*
```

```

* Examples for RM/COBOL Language Reference Manual.
* ALTER statement.
*
DATA DIVISION.
WORKING-STORAGE SECTION.
01 EMPLOYEE-RECORD.
    02 EMP-NAME          PIC X(10) .
    02 EMP-SSN          PIC 9(9) PACKED-DECIMAL.
    02 EMP-SALARY       PIC S9(8)V99 BINARY.
PROCEDURE DIVISION.
A.
    PERFORM SET-INITIALIZE-IT.

SWITCH-PARAGRAPH.
    GO TO INITIALIZE-IT.
INITIALIZE-IT.
    INITIALIZE EMPLOYEE-RECORD.
    ALTER SWITCH-PARAGRAPH TO INITIALIZED.
INITIALIZED.

SET-INITIALIZE-IT.
    ALTER SWITCH-PARAGRAPH TO INITIALIZE-IT.

END PROGRAM ALTER01.

```

CALL Statement Example

```

IDENTIFICATION DIVISION.
PROGRAM-ID. CALL01.
*
* Examples for RM/COBOL Language Reference Manual.
* CALL statement.
*
DATA DIVISION.
WORKING-STORAGE SECTION.
01 SUBPRG1          PIC X(30) .
01 CHOICE-1        PIC X(02) .
01 TABLE1.
    02 CATEGORY     OCCURS 10 INDEXED BY INX1 .
        03 CAT-DESC PIC X(10) .
        03 CAT-VALUE PIC 9(8)V99 .
01 TABLE1-TOTAL   PIC 9(10)V99 .
01 SUB-NAME-GROUP.
    02 SUBTABLE-V.
        03          PIC X(30) VALUE "APP01" .
        03          PIC X(01) VALUE "F" .
        03          PIC X(30) VALUE "APP02" .
        03          PIC X(01) VALUE "F" .
        03          PIC X(30) VALUE "APP03" .
        03          PIC X(01) VALUE "F" .
        03          PIC X(30) VALUE "APP04" .
        03          PIC X(01) VALUE "F" .
    02 SUBTABLE     REDEFINES SUBTABLE-V
        OCCURS 4 TIMES INDEXED BY IX.
        03 SUBNAME  PIC X(30) .

```

CALL Statement Example
RM/COBOL Language Examples

```
      03 SUB-LOAD-FLAG  PIC X.
      88 SUB-LOADED   VALUE "T" FALSE "F".
01 FUNCTION-TYPE      PIC X.
01 ITEM-1             PIC X(10).
01 ITEM-2             PIC X(10).
01 STATUS-1          PIC X.
01 SCREEN-BUFFER     PIC X(1920).
01 SCREEN-LINE       PIC 9(02) BINARY.
01 SCREEN-COLUMN     PIC 9(02) BINARY.
01 SUB-UNLOADED-FLAG PIC X.
      88 SUB-UNLOADED   VALUE "T" FALSE "F".
PROCEDURE DIVISION.
0010.
    IF CHOICE-1 = "01" MOVE "APP01" TO SUBPRG1
    ELSE IF CHOICE-1 = "02" MOVE "APP02" TO SUBPRG1
    ELSE PERFORM 0020-RETRY-CHOICE GO TO 0010
    END-IF END-IF.

    CALL SUBPRG1.  *>Call "APP01" or "APP02" per choice.

    CALL "REORDER" USING TABLE1 GIVING TABLE1-TOTAL.

RETRY-1.
    CALL SUBNAME OF SUBTABLE (IX) GIVING STATUS-1
    USING FUNCTION-TYPE, ITEM-1, ITEM-2,
    ON EXCEPTION PERFORM CANCEL-PARAGRAPH GO TO RETRY-1
    NOT ON EXCEPTION SET SUB-LOADED (IX) TO TRUE
    END-CALL.

    CALL "C$SCRD" USING
    SCREEN-BUFFER, OMITTED, SCREEN-LINE, SCREEN-COLUMN.

0020-RETRY-CHOICE.
    DISPLAY "Choice not recognized.  Reenter choice:  "
    WITH NO ADVANCING.
    ACCEPT CHOICE-1.

CANCEL-PARAGRAPH.
    SET SUB-UNLOADED TO FALSE.
    PERFORM VARYING IX FROM 1 BY 1 UNTIL IX > 4
    IF SUB-LOADED OF SUBTABLE (IX)
        CANCEL SUBNAME OF SUBTABLE (IX)
        SET SUB-LOADED OF SUBTABLE (IX) TO FALSE
        SET SUB-UNLOADED TO TRUE
    END-IF
    END-PERFORM.
    IF NOT SUB-UNLOADED
        DISPLAY "Insufficient memory."
        STOP RUN
    END-IF.

END PROGRAM CALL01.
IDENTIFICATION DIVISION.
PROGRAM-ID.  APP01.
DATA DIVISION.
WORKING-STORAGE SECTION.
PROCEDURE DIVISION.
```



```

0010.
    EXIT PROGRAM.
END PROGRAM APP01.
IDENTIFICATION DIVISION.
PROGRAM-ID. APP02.
DATA DIVISION.
WORKING-STORAGE SECTION.
PROCEDURE DIVISION.
0010.
    EXIT PROGRAM.
END PROGRAM APP02.
IDENTIFICATION DIVISION.
PROGRAM-ID. REORDER.
DATA DIVISION.
WORKING-STORAGE SECTION.
01 WS-TOTAL          PIC 9(10)V99.
LINKAGE SECTION.
01 T.
    02 CATEGORY      OCCURS 10 INDEXED BY INX1.
        03 CAT-DESC  PIC X(10).
        03 CAT-VALUE PIC 9(8)V99.
01 R                PIC 9(10)V99.
PROCEDURE DIVISION USING T GIVING R.
0010.
    MOVE ZERO TO WS-TOTAL.
    PERFORM VARYING INX1 FROM 1 BY 1 UNTIL
        INX1 > COUNT-MAX OF CATEGORY
        ADD CAT-VALUE(INX1) TO WS-TOTAL
    END-PERFORM.
    MOVE WS-TOTAL TO R.
    EXIT PROGRAM.
END PROGRAM REORDER.

```

CALL Program Statement Example

```

IDENTIFICATION DIVISION.
PROGRAM-ID. CALL03.
*
* Examples for RM/COBOL Language Reference Manual.
* CALL PROGRAM statement.
*
DATA DIVISION.
WORKING-STORAGE SECTION.
01 COMMON-DATA      PIC X(100).
01 CHAIN-NAME       PIC X(30).
01 ARGUMENT-AREA   PIC X(200).
01 EX-STATUS        PIC 9(03).
PROCEDURE DIVISION.
0010.
    CALL PROGRAM "MENU2" USING COMMON-DATA
    ON EXCEPTION
        DISPLAY "Chain to MENU2 failed."
    STOP RUN
    END-CALL.

```

```
0020.  
    CALL PROGRAM CHAIN-NAME USING ARGUMENT-AREA  
    ON EXCEPTION  
        ACCEPT EX-STATUS FROM EXCEPTION STATUS  
        PERFORM 0030-CHAIN-ERROR-STATUS  
        STOP RUN  
    END-CALL.  
  
0030-CHAIN-ERROR-STATUS.  
    DISPLAY "Chain to next program failed, status = "  
        EX-STATUS.  
  
END PROGRAM CALL03.
```

CANCEL Statement Example

```
IDENTIFICATION DIVISION.  
PROGRAM-ID. CANCEL01.  
*  
* Examples for RM/COBOL Language Reference Manual.  
* CANCEL statement.  
*  
DATA DIVISION.  
WORKING-STORAGE SECTION.  
01 SUBPROGRAM-NAME-HOLDER PIC X(30).  
01 SUB-NAME-GROUP.  
    02 SUBTABLE-V.  
        03 PIC X(30) VALUE "APP01".  
        03 PIC X(01) VALUE "F".  
        03 PIC X(30) VALUE "APP02".  
        03 PIC X(01) VALUE "F".  
        03 PIC X(30) VALUE "APP03".  
        03 PIC X(01) VALUE "F".  
        03 PIC X(30) VALUE "APP04".  
        03 PIC X(01) VALUE "F".  
    02 SUBTABLE REDEFINES SUBTABLE-V  
        OCCURS 4 TIMES INDEXED BY IX.  
        03 SUBNAME PIC X(30).  
        03 SUB-LOAD-FLAG PIC X.  
            88 SUB-LOADED VALUE "T" FALSE "F".  
01 SUB-UNLOADED-FLAG PIC X.  
    88 SUB-UNLOADED VALUE "T" FALSE "F".  
PROCEDURE DIVISION.  
0010.  
  
    CANCEL "SUB01", "SUB02".  
  
    CANCEL SUBPROGRAM-NAME-HOLDER.  
  
CANCEL-PARAGRAPH.  
    SET SUB-UNLOADED TO FALSE.  
    PERFORM VARYING IX FROM 1 BY 1 UNTIL IX > 4  
        IF SUB-LOADED OF SUBTABLE (IX)  
            CANCEL SUBNAME OF SUBTABLE (IX)  
            SET SUB-LOADED OF SUBTABLE (IX) TO FALSE
```

```
        SET SUB-UNLOADED TO TRUE
        END-IF
    END-PERFORM.
    IF NOT SUB-UNLOADED
        DISPLAY "Insufficient memory."
        STOP RUN
    END-IF.

END PROGRAM CANCEL01.
IDENTIFICATION DIVISION.
PROGRAM-ID. SUB01.
DATA DIVISION.
WORKING-STORAGE SECTION.
PROCEDURE DIVISION.
0010.
    EXIT PROGRAM.
END PROGRAM SUB01.
IDENTIFICATION DIVISION.
PROGRAM-ID. SUB02.
DATA DIVISION.
WORKING-STORAGE SECTION.
PROCEDURE DIVISION.
0010.
    EXIT PROGRAM.
END PROGRAM SUB02.
```

CLOSE Statement Example

```
IDENTIFICATION DIVISION.
PROGRAM-ID. CLOSE01.
*
* Examples for RM/COBOL Language Reference Manual.
* CLOSE statement.
*
ENVIRONMENT DIVISION.
INPUT-OUTPUT SECTION.
FILE-CONTROL.
    SELECT TRANSACTION-FILE ASSIGN TO TAPE.
    SELECT LOG-FILE          ASSIGN TO DISK
                                FILE STATUS IS LOG-FILE-STATUS.

    SELECT INPUT-FILE        ASSIGN TO TAPE.
    SELECT TAPE-FILE-1       ASSIGN TO TAPE.
    SELECT PRINT-FILE        ASSIGN TO PRINTER.
    SELECT DATA-BASE        ASSIGN TO DISK
                                INDEXED ACCESS DYNAMIC
                                RECORD KEY IS DB-KEY
                                FILE STATUS IS DB-STATUS.

DATA DIVISION.
FILE SECTION.
FD TRANSACTION-FILE.
01 TR-RECORD                PIC X(80).

FD LOG-FILE.
01 LOG-RECORD              PIC X(80).
```

```
FD INPUT-FILE.
01 IN-RECORD          PIC X(80).

FD TAPE-FILE-1.
01 TF1-RECORD        PIC X(512).

FD PRINT-FILE.
01 PF-RECORD         PIC X(60).

FD DATA-BASE.
01 DB-RECORD.
   02 DB-DATA-1      PIC X(10).
   02 DB-KEY         PIC X(20).
   02 DB-DATA-2     PIC X(50).

WORKING-STORAGE SECTION.
01 LOG-FILE-STATUS   PIC X(02).
01 DB-STATUS         PIC X(02).
PROCEDURE DIVISION.
DECLARATIVES.
I-O-ERROR SECTION.
   USE AFTER STANDARD EXCEPTION PROCEDURE ON I-O.
I-O-ERROR1.
   EXIT.
END DECLARATIVES.
MAIN-01 SECTION.
0010.
   CLOSE TRANSACTION-FILE.

   CLOSE LOG-FILE WITH LOCK, PRINT-FILE.

   OPEN I-O LOG-FILE.
   IF LOG-FILE-STATUS = "38"
      DISPLAY "Log file closed with lock."
      STOP RUN
   END-IF.

   CLOSE INPUT-FILE REEL FOR REMOVAL.

   CLOSE TAPE-FILE-1 WITH NO REWIND.

   CLOSE DATA-BASE WITH LOCK.

   OPEN I-O DATA-BASE.
   IF DB-STATUS = "38"
      DISPLAY "Data-base file closed with lock."
      STOP RUN
   END-IF.

END PROGRAM CLOSE01.
```

COMPUTE Statement Example

IDENTIFICATION DIVISION.

```

PROGRAM-ID.  COMPUTE1.
*
*  Examples for RM/COBOL Language Reference Manual.
*    COMPUTE statement.
*
DATA DIVISION.
WORKING-STORAGE SECTION.
01 WAGES                PIC  9(6)V99.
01 REGULAR-HOURS        PIC  S9(4)V99.
01 OVERTIME-HOURS       PIC  S9(4)V99.
01 TOTAL-HOURS          PIC  S9(4)V99.
01 SALARY                PIC  S9(10)V99.
01 TIME-REC.
   02 HRS                PIC  9(2) .
   02 MIN                PIC  9(2) .
   02 SEC                PIC  9(2)V9(2) .
01 SECONDS              PIC  9(5)V9(2) .
01 AVERAGE              PIC  9(5)V9(2) .
01 TOTAL-1              PIC  S9(10)V9(4) .
01 COUNT-1              PIC  S9(5) .
01 PAYMENT-RND          PIC  S9(6)V9(2) .
01 PAYMENT-TRUNC        PIC  S9(6)V9(4) .
01 INITIAL-PRINCIPAL    PIC  S9(8)V9(2) VALUE 1000.00.
01 INTEREST-APR         PIC  S9(4)V9(4) VALUE 8.25.
01 INTEREST-PER-PERIOD  PIC  S9(4)V9(4) .
01 NUMBER-OF-PERIODS    PIC  S9(4)      VALUE 36.
01 DUMMY                PIC  X.
PROCEDURE DIVISION.
A.
  COMPUTE TOTAL-HOURS = REGULAR-HOURS + OVERTIME-HOURS.
  IF TOTAL-HOURS > 80
    PERFORM EXCEPTIONAL-HOURS-PROC.

  COMPUTE SALARY ROUNDED = WAGES * REGULAR-HOURS
    + WAGES * OVERTIME-HOURS * 1.5.

  COMPUTE SECONDS = ((HRS * 60) + MIN) * 60 + SEC
  ON SIZE ERROR
    DISPLAY "Time value out of range."
    STOP RUN
  END-COMPUTE.

  COMPUTE AVERAGE = TOTAL-1 / COUNT-1
  ON SIZE ERROR MOVE 0 TO AVERAGE END-COMPUTE.

  COMPUTE INTEREST-PER-PERIOD ROUNDED =
    INTEREST-APR / 1200.
  COMPUTE PAYMENT-RND ROUNDED PAYMENT-TRUNC =
    (INITIAL-PRINCIPAL * INTEREST-PER-PERIOD) /
    (1 - (1 + INTEREST-PER-PERIOD) **
    (- NUMBER-OF-PERIODS)).

  DISPLAY "PAYMENT-RND   = " PAYMENT-RND CONVERT.
  DISPLAY "PAYMENT-TRUNC = " PAYMENT-TRUNC CONVERT.
  ACCEPT DUMMY PROMPT "#".

EXCEPTIONAL-HOURS-PROC.

```

```
EXIT.  
  
END PROGRAM COMPUTE1.
```

CONTINUE Statement Example

```
IDENTIFICATION DIVISION.  
PROGRAM-ID. CONTINUE01.  
*  
* Examples for RM/COBOL Language Reference Manual.  
* CONTINUE statement.  
*  
ENVIRONMENT DIVISION.  
CONFIGURATION SECTION.  
  
DATA DIVISION.  
WORKING-STORAGE SECTION.  
01 NORMAL-RESULT          PIC X.  
01 PART-DESCRIPTION       PIC X(30).  
01 EXCP-CODE              PIC 9(3).  
PROCEDURE DIVISION.  
0010.  
    CONTINUE.  
  
    IF NORMAL-RESULT = "Y"  
        CONTINUE  
    ELSE  
        PERFORM EXCEPTION-CASE-ANALYSIS  
    END-IF.  
  
    ACCEPT PART-DESCRIPTION UPDATE ERASE EOL  
        ON EXCEPTION EXCP-CODE CONTINUE END-ACCEPT.  
  
    STOP RUN.  
  
EXCEPTION-CASE-ANALYSIS.  
    EXIT.  
  
END PROGRAM CONTINUE01.
```

DELETE Statement Example

```
IDENTIFICATION DIVISION.  
PROGRAM-ID. DELETE01.  
*  
* Examples for RM/COBOL Language Reference Manual.  
* DELETE statement (relative and indexed I-O).  
*  
ENVIRONMENT DIVISION.  
INPUT-OUTPUT SECTION.  
FILE-CONTROL.  
    SELECT INVENTORY-FILE    ASSIGN TO DISK
```

```

                                RELATIVE ACCESS RANDOM
                                RELATIVE KEY IS INV-KEY.

SELECT DATA-BASE              ASSIGN TO DISK
                                INDEXED ACCESS DYNAMIC
                                RECORD KEY IS DB-KEY
                                FILE STATUS IS DB-STATUS.

SELECT STATUS-FILE            ASSIGN TO DISK
                                RELATIVE ACCESS RANDOM
                                RELATIVE KEY IS SF-KEY.

DATA DIVISION.
FILE SECTION.
FD INVENTORY-FILE.
01 INVENTORY-RECORD          PIC X(80).

FD DATA-BASE.
01 DB-RECORD.
   02 DB-DATA-1              PIC X(10).
   02 DB-KEY                 PIC X(20).
   02 DB-DATA-2              PIC X(50).

FD STATUS-FILE.
01 STATUS-RECORD            PIC X(1).

WORKING-STORAGE SECTION.
01 DB-STATUS                 PIC X(02).
01 DB-DELETE-KEY             PIC X(20).
01 INV-KEY                   PIC 9(5) BINARY.
01 SF-KEY                    PIC 9(5) BINARY.

PROCEDURE DIVISION.
DECLARATIVES.
I-O-ERROR SECTION.
    USE AFTER STANDARD EXCEPTION PROCEDURE ON I-O.
I-O-ERROR1.
    EXIT.
END DECLARATIVES.
MAIN-01 SECTION.
0010.

    DELETE INVENTORY-FILE RECORD; INVALID KEY
        PERFORM BAD-KEY-PROCEDURE END-DELETE.

    DELETE STATUS-FILE RECORD.

    MOVE DB-DELETE-KEY TO DB-KEY.
    DELETE DATA-BASE RECORD
    INVALID KEY PERFORM DB-INVALID-KEY-HANDLER
    NOT INVALID KEY PERFORM DB-SUCCESS-HANDLER
    END-DELETE.
BAD-KEY-PROCEDURE.
    EXIT.

DB-SUCCESS-HANDLER.
    EXIT.
```

```
DB-INVALID-KEY-HANDLER.  
    EXIT.  
  
END PROGRAM DELETE01.
```

DELETE FILE Statement Example

```
IDENTIFICATION DIVISION.  
PROGRAM-ID.  DELETE02.  
*  
*  Examples for RM/COBOL Language Reference Manual.  
*  DELETE FILE statement.  
*  
ENVIRONMENT DIVISION.  
INPUT-OUTPUT SECTION.  
FILE-CONTROL.  
    SELECT TEMP-FILE-1          ASSIGN TO DISK.  
  
    SELECT TEMP-FILE-2          ASSIGN TO DISK.  
  
    SELECT OLD-TRANSACTION-FILE  
                                ASSIGN TO DISK.  
  
DATA DIVISION.  
FILE SECTION.  
FD TEMP-FILE-1.  
01 TF1-RECORD                  PIC X(80).  
  
FD TEMP-FILE-2.  
01 TF2-RECORD                  PIC X(80).  
  
FD OLD-TRANSACTION-FILE.  
01 OTF-RECORD.  
    02 DB-DATA-1                PIC X(10).  
    02 DB-KEY                    PIC X(20).  
    02 DB-DATA-2                PIC X(50).  
  
WORKING-STORAGE SECTION.  
PROCEDURE DIVISION.  
DECLARATIVES.  
I-O-ERROR SECTION.  
    USE AFTER STANDARD EXCEPTION PROCEDURE ON I-O.  
I-O-ERROR1.  
    EXIT.  
END DECLARATIVES.  
MAIN-01 SECTION.  
0010.  
  
    DELETE FILE TEMP-FILE-1 TEMP-FILE-2.  
  
    DELETE FILE OLD-TRANSACTION-FILE END-DELETE.  
  
END PROGRAM DELETE02.
```

DISABLE Statement Example

```
IDENTIFICATION DIVISION.
PROGRAM-ID.  DISABLE1.
*
*  Examples for RM/COBOL Language Reference Manual.
*  DISABLE statement.
*
DATA DIVISION.
WORKING-STORAGE SECTION.
01 COM-PASSWORD          PIC X(30) .
COMMUNICATION SECTION.
CD INPUT-COM FOR INPUT
    SYMBOLIC QUEUE IS INPUT-SYMQ
    SYMBOLIC SUB-QUEUE-1 IS INPUT-SYM-SUBQ1
    SYMBOLIC SUB-QUEUE-2 IS INPUT-SYM-SUBQ2
    SYMBOLIC SUB-QUEUE-3 IS INPUT-SYM-SUBQ3
    MESSAGE DATE IS INPUT-MSG-DT
    MESSAGE TIME IS INPUT-MSG-TM
    SYMBOLIC SOURCE IS INPUT-SYM-SRC
    TEXT LENGTH IS INPUT-TXT-LENGTH
    END KEY IS INPUT-END-KEY
    STATUS KEY IS INPUT-STATUS-KEY
    MESSAGE COUNT IS INPUT-MSG-COUNT.

CD COM-LINE-1 FOR OUTPUT
    DESTINATION COUNT IS L1-DEST-COUNT
    TEXT LENGTH IS L1-TEXT-LENGTH
    STATUS KEY IS L1-STATUS-KEY
    DESTINATION TABLE OCCURS 5 TIMES
        INDEXED BY L1IX1, L1IX2
    ERROR KEY IS L1-ERROR-KEY
    SYMBOLIC DESTINATION IS L1-SYM-DEST.

PROCEDURE DIVISION.
0010.

        DISABLE INPUT INPUT-COM.

        DISABLE OUTPUT COM-LINE-1 WITH KEY COM-PASSWORD.

END PROGRAM DISABLE1.
```

DISPLAY Statement Examples

DISPLAY Format 1

```
IDENTIFICATION DIVISION.
PROGRAM-ID.  DISPLAY1.
*
*  Examples for RM/COBOL Language Reference Manual.
*  DISPLAY Format 1 (DISPLAY ... UPON) statement.
```

```
*
ENVIRONMENT DIVISION.
CONFIGURATION SECTION.
SPECIAL-NAMES.
    SYSOUT IS SYSTEM-OUTPUT.

DATA DIVISION.
WORKING-STORAGE SECTION.
01 PROMPT-STRING      PIC X(5) VALUE "HELLO".
01 OPERATOR-MESSAGE  PIC X(70).
01 DUMMY              PIC X.
PROCEDURE DIVISION.
0010.
    DISPLAY "[" PROMPT-STRING "]" " UPON SYSTEM-OUTPUT
        WITH NO ADVANCING.

    DISPLAY OPERATOR-MESSAGE UPON CONSOLE.

    ACCEPT DUMMY PROMPT.

END PROGRAM DISPLAY1.
```

DISPLAY Format 2

```
IDENTIFICATION DIVISION.
PROGRAM-ID. DISPLAY2.
*
* Examples for RM/COBOL Language Reference Manual.
* DISPLAY Format 2 (Terminal I-O) statement.
*
ENVIRONMENT DIVISION.
CONFIGURATION SECTION.
SPECIAL-NAMES.
    SYSOUT IS SYSTEM-OUTPUT.

DATA DIVISION.
WORKING-STORAGE SECTION.
01 FLT-LN              PIC 9(2) BINARY VALUE 10.
01 GATE-NUMBER         PIC 9(3).
01 MENU-HEADER        PIC X(70).
01 REPORT-LINE        PIC X(40).
01 display-group.
    02 display-table   OCCURS 5 TIMES INDEXED BY IX.
        03 display-data PIC X(80).
        03 display-line PIC 9(2) BINARY.
        03 display-column PIC 9(2) BINARY.
        03 display-size PIC 9(2) BINARY.
        03 display-control PIC X(80).
01 DUMMY              PIC X.
PROCEDURE DIVISION.
0010.
    DISPLAY "Flight arriving at gate:", LINE FLT-LN,
        POSITION 1, ERASE; GATE-NUMBER, HIGH, BLINK.

    DISPLAY "Enter job code: " LINE 12 COLUMN 5.
```

```
DISPLAY MENU-HEADER LINE 1 ERASE HIGH.

DISPLAY ZEROES SIZE 5.  *> displays "00000"

DISPLAY QUOTE.  *> displays """" (one quote character)

DISPLAY REPORT-LINE CONTROL "HIGH, ERASE EOL".

DISPLAY display-data (ix),
      LINE display-line (ix),
      COL display-column (ix),
      SIZE display-size (ix),
      CONTROL display-control (ix).

ACCEPT DUMMY PROMPT.

END PROGRAM DISPLAY2.
```

DISPLAY Format 3

```
IDENTIFICATION DIVISION.
PROGRAM-ID. DISPLAY3.
*
* Examples for RM/COBOL Language Reference Manual.
* DISPLAY Format 3
*
DATA DIVISION.
WORKING-STORAGE SECTION.
01 WS-INV-DT          PIC 9(8) VALUE 02031999.
01 WS-INV-AMT        PIC S9(7) VALUE 0.
78 EMP-NAME-SIZE     VALUE 30.
78 EMP-LOC-SIZE      VALUE 15.
01 WS-EMP-NAME       PIC X(EMP-NAME-SIZE) VALUE SPACES.
01 WS-EMP-LOC        PIC X(EMP-LOC-SIZE) VALUE SPACES.
01 EOB-COL           PIC 9(2) BINARY VALUE 10.
01 EOB-LINE          PIC 9(2) BINARY VALUE 15.
SCREEN SECTION.
01 INVOICE-FORM.
   02 BLANK SCREEN.
   02 "Invoice date:  ".
   02 INVOICE-DATE PIC 99/99/9999 FROM WS-INV-DT
      TO WS-INV-DT.
   02 "Invoice amount: " LINE.
   02 INVOICE-AMOUNT PIC 9(5).99CR USING WS-INV-AMT.
01 EMPLOYEE-RECORD.
   02 BLANK SCREEN.
   02 "Employee name:  ".
   02 ER-NAME        PIC X(EMP-NAME-SIZE) USING WS-EMP-NAME.
   02 "Employee loc: " LINE.
   02 ER-LOC         PIC X(EMP-LOC-SIZE) USING WS-EMP-LOC.
01 EOB-SCREEN.
   02 ERASE.
   02 "Explanation of Benefits Screen".
   02 "Benefit amount: " LINE + 2 COL 10.
   02 EOB-AMOUNT     PIC 9(5).99DB USING WS-INV-AMT.
```

```
PROCEDURE DIVISION.  
A.  
  
    DISPLAY INVOICE-FORM LINE 10 COLUMN 5.  
    ACCEPT INVOICE-FORM LINE 10 COLUMN 5.  
  
    DISPLAY EMPLOYEE-RECORD AT LINE 9.  
    ACCEPT EMPLOYEE-RECORD AT LINE 9.  
  
    DISPLAY EOB-SCREEN AT COL EOB-COL LINE EOB-LINE.  
    ACCEPT EOB-SCREEN AT COL EOB-COL LINE EOB-LINE.  
  
END PROGRAM DISPLAY3.
```

DIVIDE Statement Example

```
IDENTIFICATION DIVISION.  
PROGRAM-ID.  DIVIDE01.  
*  
*  Examples for RM/COBOL Language Reference Manual.  
*  DIVIDE statement.  
*  
DATA DIVISION.  
WORKING-STORAGE SECTION.  
01 TOTAL-WORK-LOAD      PIC 9(08)V99.  
01 AVERAGE-WORK-LOAD   PIC 9(08)V99.  
01 DIVIDEND-1          PIC S9(08)V99.  
01 DIVISOR-1           PIC S9(08)V99.  
01 QUOTIENT-1          PIC S9(08)V99.  
01 REMAINDER-1         PIC S9(08)V99.  
01 SIZE-ERROR-FLAG     PIC X VALUE SPACE.  
PROCEDURE DIVISION.  
A.  
  
    DIVIDE 10 INTO TOTAL-WORK-LOAD. *> 10 FTEs  
  
    DIVIDE 6 INTO TOTAL-WORK-LOAD  *> 6 FTEs  
    GIVING AVERAGE-WORK-LOAD.  
  
    DIVIDE TOTAL-WORK-LOAD BY 2.5  *> 2.5 FTEs  
    GIVING AVERAGE-WORK-LOAD  
    ON SIZE ERROR PERFORM OVERFLOW-ROUTINE  
    END-DIVIDE.  
  
    DIVIDE DIVISOR-1 INTO DIVIDEND-1  
    GIVING QUOTIENT-1 ROUNDED  
    REMAINDER REMAINDER-1.  
  
    DIVIDE DIVIDEND-1 BY DIVISOR-1  
    GIVING QUOTIENT-1  
    REMAINDER REMAINDER-1  
    ON SIZE ERROR  MOVE "E" TO SIZE-ERROR-FLAG  
    END-DIVIDE.  
  
OVERFLOW-ROUTINE.  
EXIT.
```

```
END PROGRAM DIVIDE01.
```

ENABLE Statement Example

```
IDENTIFICATION DIVISION.
PROGRAM-ID.  ENABLE1.
*
*  Examples for RM/COBOL Language Reference Manual.
*  ENABLE statement.
*
DATA DIVISION.
WORKING-STORAGE SECTION.
01 COM-PASSWORD          PIC X(30).
COMMUNICATION SECTION.
CD COM-PORT FOR INPUT
  SYMBOLIC QUEUE IS COM-PORT-SYMQ
  SYMBOLIC SUB-QUEUE-1 IS COM-PORT-SYM-SUBQ1
  SYMBOLIC SUB-QUEUE-2 IS COM-PORT-SYM-SUBQ2
  SYMBOLIC SUB-QUEUE-3 IS COM-PORT-SYM-SUBQ3
  MESSAGE DATE IS COM-PORT-MSG-DT
  MESSAGE TIME IS COM-PORT-MSG-TM
  SYMBOLIC SOURCE IS COM-PORT-SYM-SRC
  TEXT LENGTH IS COM-PORT-TXT-LENGTH
  END KEY IS COM-PORT-END-KEY
  STATUS KEY IS COM-PORT-STATUS-KEY
  MESSAGE COUNT IS COM-PORT-MSG-COUNT.

CD COM-LINE-1 FOR OUTPUT
  DESTINATION COUNT IS L1-DEST-COUNT
  TEXT LENGTH IS L1-TEXT-LENGTH
  STATUS KEY IS L1-STATUS-KEY
  DESTINATION TABLE OCCURS 5 TIMES
    INDEXED BY L1IX1, L1IX2
  ERROR KEY IS L1-ERROR-KEY
  SYMBOLIC DESTINATION IS L1-SYM-DEST.

PROCEDURE DIVISION.
0010.

    ENABLE INPUT TERMINAL COM-PORT.

    ENABLE OUTPUT COM-LINE-1 WITH KEY COM-PASSWORD.

END PROGRAM ENABLE1.
```

ENTER Statement Example

```
IDENTIFICATION DIVISION.
PROGRAM-ID.  ENTER01.
*
*  Examples for RM/COBOL Language Reference Manual.
```

```
* ENTER statement.  
*  
ENVIRONMENT DIVISION.  
CONFIGURATION SECTION.  
  
DATA DIVISION.  
WORKING-STORAGE SECTION.  
01 ARGUMENT-GROUP.  
    02 ARG1                PIC X(10).  
    02 ARG2                PIC X(05).  
PROCEDURE DIVISION.  
0010.  
  
    ENTER LINKAGE.  
    CALL "SUBROUTINE" USING ARGUMENT-GROUP.  
    ENTER COBOL.  
  
    ENTER FORTRAN SUBROUTINE-1.  
  
END PROGRAM ENTER01.
```

EVALUATE Statement Example

```
IDENTIFICATION DIVISION.  
PROGRAM-ID. EVALUAT1.  
*  
* Examples for RM/COBOL Language Reference Manual.  
* EVALUATE statement.  
*  
ENVIRONMENT DIVISION.  
CONFIGURATION SECTION.  
  
DATA DIVISION.  
WORKING-STORAGE SECTION.  
01 OPERATION-TYPE        PIC X.  
01 TYPE-UPDATE          PIC X VALUE "U".  
01 TYPE-DELETE          PIC X VALUE "D".  
01 TYPE-INSERT          PIC X VALUE "I".  
01 DAY-VALUE            PIC 9.  
01 LEVEL-VALUE          PIC X(8).  
    88 L-DETAILED        VALUE "DETAILED".  
    88 L-SUMMARY         VALUE "SUMMARY".  
01 UPDATE-TYPE          PIC X.  
    88 ANNUALLY          VALUE "A".  
    88 QUARTERLY         VALUE "Q".  
    88 MONTHLY           VALUE "M".  
01 YEAR-END-FLAG        PIC X.  
    88 YEAR-END          VALUE "T" FALSE "F".  
01 QUARTER-END-FLAG     PIC X.  
    88 QUARTER-END       VALUE "T" FALSE "F".  
01 MONTH-END-FLAG       PIC X.  
    88 MONTH-END         VALUE "T" FALSE "F".  
PROCEDURE DIVISION.  
0010.  
    EVALUATE OPERATION-TYPE
```

```
WHEN TYPE-UPDATE PERFORM UPDATE-IT
WHEN TYPE-DELETE PERFORM DELETE-IT
WHEN TYPE-INSERT PERFORM INSERT-IT
WHEN OTHER PERFORM BAD-OPERATION-TYPE
END-EVALUATE.
```

```
EVALUATE DAY-VALUE ALSO LEVEL-VALUE
WHEN 1 ALSO ANY          PERFORM MONDAY-PROCESSING
WHEN 2 THRU 4 ALSO "SUMMARY"
    PERFORM MIDWEEK-PROCESSING
WHEN 2 ALSO "DETAILED" PERFORM TUESDAY-PROCESSING
WHEN 3 ALSO "DETAILED" PERFORM WEDNESDAY-PROCESSING
WHEN 4 ALSO "DETAILED" PERFORM THURSDAY-PROCESSING
WHEN 5 ALSO ANY          PERFORM FRIDAY-PROCESSING
WHEN 6 ALSO ANY
WHEN 7 ALSO ANY          PERFORM WEEKEND-PROCESSING
WHEN OTHER              PERFORM BAD-DAY-OR-LEVEL
END-EVALUATE.
```

```
EVALUATE TRUE
WHEN ANNUALLY AND YEAR-END
    PERFORM ANNUAL-UPDATE
WHEN QUARTERLY AND QUARTER-END
    PERFORM QUARTER-UPDATE
WHEN MONTHLY AND MONTH-END
    PERFORM MONTH-UPDATE
END-EVALUATE.
```

```
UPDATE-IT.
DELETE-IT.
INSERT-IT.
BAD-OPERATION-TYPE.
```

```
MIDWEEK-PROCESSING.
MONDAY-PROCESSING.
TUESDAY-PROCESSING.
WEDNESDAY-PROCESSING.
THURSDAY-PROCESSING.
FRIDAY-PROCESSING.
WEEKEND-PROCESSING.
BAD-DAY-OR-LEVEL.
```

```
ANNUAL-UPDATE.
QUARTER-UPDATE.
MONTH-UPDATE.
```

```
END PROGRAM EVALUAT1.
```

EXIT Statement Example

```
IDENTIFICATION DIVISION.
PROGRAM-ID. EXIT01.
```

- *
- * Examples for RM/COBOL Language Reference Manual.
- * EXIT statement.

EXIT Statement Example
RM/COBOL Language Examples

```
*
ENVIRONMENT DIVISION.
CONFIGURATION SECTION.

DATA DIVISION.
WORKING-STORAGE SECTION.
01 RECORD-TYPE          PIC X(4) .
01 MY-RECORD-TYPE      PIC X(4) VALUE "TRAN".
01 EXIT-LOOP-FLAG      PIC X.
01 EXIT-CYCLE-FLAG     PIC X.
PROCEDURE DIVISION.
PRIMARY SECTION.
0010.
    PERFORM WEEKEND-PROC THRU WEEKEND-PROC-EXIT.

WEEKEND-PROC.

WEEKEND-PROC-CONT.

WEEKEND-PROC-EXIT.
    EXIT.

0020.
    IF RECORD-TYPE NOT = MY-RECORD-TYPE
    THEN
        MOVE 4096 TO RETURN-CODE
        EXIT PROGRAM
    END-IF.

    IF RECORD-TYPE = MY-RECORD-TYPE
    EXIT PARAGRAPH
    END-IF.

    PERFORM UNTIL RECORD-TYPE = MY-RECORD-TYPE
        PERFORM WEEKEND-PROC THRU WEEKEND-PROC-EXIT
        IF EXIT-LOOP-FLAG = "Y"
            EXIT PERFORM
        END-IF
        IF EXIT-CYCLE-FLAG = "Y"
            EXIT PERFORM CYCLE
        END-IF
    PERFORM 0010
    *> CONTINUE from EXIT PERFORM CYCLE statement
    END-PERFORM.
    *> CONTINUE from EXIT PERFORM statement

0030.
    IF RECORD-TYPE = MY-RECORD-TYPE
    EXIT SECTION
    END-IF.

END PROGRAM EXIT01.
```

GOBACK Statement Example

```
IDENTIFICATION DIVISION.
PROGRAM-ID.  GOBACK01.
*
*  Examples for RM/COBOL Language Reference Manual.
*  GOBACK statement.
*
ENVIRONMENT DIVISION.
CONFIGURATION SECTION.

DATA DIVISION.
WORKING-STORAGE SECTION.
01 RECORD-TYPE          PIC X(4) .
01 MY-RECORD-TYPE      PIC X(4) VALUE "TRAN".
PROCEDURE DIVISION.
0010.
    GOBACK.
0020.
    IF RECORD-TYPE NOT = MY-RECORD-TYPE
    THEN
        MOVE 4096 TO RETURN-CODE
        GOBACK
    END-IF.

END PROGRAM GOBACK01.
```

GO TO Statement Example

```
IDENTIFICATION DIVISION.
PROGRAM-ID.  GOTO01.
*
*  Examples for RM/COBOL Language Reference Manual.
*  GOBACK statement.
*
ENVIRONMENT DIVISION.
CONFIGURATION SECTION.

DATA DIVISION.
WORKING-STORAGE SECTION.
01 STATE-1-FLAG        PIC X(1) .
    88 STATE-1-UP      VALUE "U".
    88 STATE-1-DOWN    VALUE "D".
01 USER-PICK           PIC 9.
PROCEDURE DIVISION.
0010.
    IF STATE-1-UP
        ALTER STATE-1-SWITCH TO STATE-1-UP-PROC
    ELSE
        ALTER STATE-1-SWITCH TO STATE-1-DOWN-PROC.

STATE-1-SWITCH.
    GO TO.
```

```
STATE-1-UP-PROC.  
  
STATE-1-DOWN-PROC.  
  
0020.  
    GO TO STATE-1-EXIT-PROC.  
  
STATE-1-EXIT-PROC.  
  
0030.  
    GO TO CHOICE-1, CHOICE-2, CHOICE-3  
        DEPENDING ON USER-PICK.  
  
CHOICE-1.  
CHOICE-2.  
CHOICE-3.  
  
END PROGRAM GOTO01.
```

IF Statement Example

```
IDENTIFICATION DIVISION.  
PROGRAM-ID.  IF01.  
*  
*  Examples for RM/COBOL Language Reference Manual.  
*  IF statement.  
*  
ENVIRONMENT DIVISION.  
CONFIGURATION SECTION.  
SPECIAL-NAMES.  
    SWITCH-1 IS PRINT-SWITCH  
        ON STATUS IS PRINT-SWITCH-ON.  
  
DATA DIVISION.  
WORKING-STORAGE SECTION.  
01 CHAR-STR          PIC X(10).  
01 ALPHA-STR        PIC X(10).  
01 NUM              PIC 9(10).  
01 OLD-NUM          PIC 9(10).  
01 ERROR-CNT        PIC 9(5) BINARY.  
01 UPPER-LIMIT      PIC 9(10) VALUE 4000000000.  
PROCEDURE DIVISION.  
0010.  
    IF CHAR-STR IS ALPHABETIC  
    THEN MOVE CHAR-STR TO ALPHA-STR;  
    ELSE IF CHAR-STR IS NUMERIC  
    THEN MOVE CHAR-STR TO NUM;  
    ELSE NEXT SENTENCE.  
  
0020.  
    IF NUM = OLD-NUM GO TO RE-SET.  
  
0030.  
    IF ALPHA-STR NOT = "TEST"  
    ADD 1 TO ERROR-CNT
```

```
        IF ERROR-CNT >= 20
            DISPLAY "Excessive errors."
            STOP RUN
        END-IF
    ELSE
        PERFORM TEST-PROCEDURE
    END-IF.

0040.
    IF NUM < UPPER-LIMIT, ADD 1 TO NUM.

0050.
    IF NUM IS LESS THAN UPPER-LIMIT
    THEN
        ADD 1 TO NUM
    ELSE
        PERFORM RE-SET
    END-IF.

0060.
    IF PRINT-SWITCH-ON PERFORM PRINT-ROUTINE.

RE-SET.
TEST-PROCEDURE.
PRINT-ROUTINE.

END PROGRAM IF01.
```

INITIALIZE Statement Example

```
IDENTIFICATION DIVISION.
PROGRAM-ID.  INITLZ01.
*
*  Examples for RM/COBOL Language Reference Manual.
*  INITIALIZE statement.
*
ENVIRONMENT DIVISION.
CONFIGURATION SECTION.

DATA DIVISION.
WORKING-STORAGE SECTION.
01 EMPLOYEE-RECORD.
    02 EMP-NAME           PIC X(30) .
    02 EMP-SALARY        PIC S9(8)V99.
    02 EMP-DEPARTMENT    PIC X(20) VALUE "CORPORATE".
    02 FILLER            PIC A(20) .
01 HR-RECORD.
    02 HR-DEPARTMENT     PIC X(20) .
    02 HR-GROUP          PIC X(20) .
    02 HR-SALARY-TOTAL   PIC S9(10)V99.

PROCEDURE DIVISION.
0010.
    INITIALIZE EMPLOYEE-RECORD HR-RECORD.
```

```
INITIALIZE EMPLOYEE-RECORD
  REPLACING NUMERIC DATA BY ZERO
        ALPHANUMERIC DATA BY ALL "#".

INITIALIZE HR-RECORD
  REPLACING NUMERIC DATA BY 100.00.

INITIALIZE EMPLOYEE-RECORD HR-RECORD
  WITH FILLER
  ALL TO VALUE
  THEN REPLACING
        ALPHANUMERIC ALPHABETIC DATA BY ALL "#"
  THEN TO DEFAULT.

END PROGRAM INITLZ01.
```

INSPECT Statement Example

```
IDENTIFICATION DIVISION.
PROGRAM-ID.  INSPECT1.
*
*  Examples for RM/COBOL Language Reference Manual.
*  INSPECT statement.
*
ENVIRONMENT DIVISION.
CONFIGURATION SECTION.

DATA DIVISION.
WORKING-STORAGE SECTION.
01 WORD-1          PIC X(9) .
01 COUNT-1        PIC 9(4) .
01 COUNT-2        PIC 9(4) .
PROCEDURE DIVISION.
0010.
  MOVE "LARGE" TO WORD-1.
  PERFORM EXAMPLE1.
  IF COUNT-1 = 1 AND COUNT-2 = 0
    DISPLAY "Example 1a passed."
  ELSE
    DISPLAY "Example 1a failed."
  END-IF.

  MOVE "ANALYST" TO WORD-1.
  PERFORM EXAMPLE1.
  IF COUNT-1 = 0 AND COUNT-2 = 1
    DISPLAY "Example 1b passed."
  ELSE
    DISPLAY "Example 1b failed."
  END-IF.

0020.
  MOVE "CALLAR" TO WORD-1.
  PERFORM EXAMPLE2.
  IF COUNT-1 = 2 AND WORD-1 = "CALLER"
    DISPLAY "Example 2a passed."
```

```
ELSE
  DISPLAY "Example 2a failed."
END-IF.

MOVE "SALAMI" TO WORD-1.
PERFORM EXAMPLE2.
IF COUNT-1 = 1 AND WORD-1 = "SALEMI"
  DISPLAY "Example 2b passed."
ELSE
  DISPLAY "Example 2b failed."
END-IF.

MOVE "LATTER" TO WORD-1.
PERFORM EXAMPLE2.
IF COUNT-1 = 1 AND WORD-1 = "LETTER"
  DISPLAY "Example 2c passed."
ELSE
  DISPLAY "Example 2c failed."
END-IF.
```

0030.

```
MOVE "ARXAX" TO WORD-1.
PERFORM EXAMPLE3.
IF WORD-1 = "GRXAX"
  DISPLAY "Example 3a passed."
ELSE
  DISPLAY "Example 3a failed."
END-IF.
```

```
MOVE "HANDAX" TO WORD-1.
PERFORM EXAMPLE3.
IF WORD-1 = "HGNDGX"
  DISPLAY "Example 3b passed."
ELSE
  DISPLAY "Example 3b failed."
END-IF.
```

0040.

```
MOVE "ADJECTIVE" TO WORD-1.
PERFORM EXAMPLE4.
IF COUNT-1 = 6 AND WORD-1 = "BDJECTIVE"
  DISPLAY "Example 4a passed."
ELSE
  DISPLAY "Example 4a failed."
END-IF.
```

```
MOVE "JACK" TO WORD-1.
PERFORM EXAMPLE4.
IF COUNT-1 = 3 AND WORD-1 = "JBCK"
  DISPLAY "Example 4b passed."
ELSE
  DISPLAY "Example 4b failed."
END-IF.
```

```
MOVE "JUJMAB" TO WORD-1.
PERFORM EXAMPLE4.
IF COUNT-1 = 5 AND WORD-1 = "JUJMAB"
```

INSPECT Statement Example
RM/COBOL Language Examples

```
    DISPLAY "Example 4c passed."  
ELSE  
    DISPLAY "Example 4c failed."  
END-IF.
```

0050.

```
MOVE "RXXBQWY" TO WORD-1.  
PERFORM EXAMPLE5.  
IF WORD-1 = "RYYZQQY"  
    DISPLAY "Example 5a passed."  
ELSE  
    DISPLAY "Example 5a failed."  
END-IF.
```

```
MOVE "YZACDWBR" TO WORD-1.  
PERFORM EXAMPLE5.  
IF WORD-1 = "YZACDWZR"  
    DISPLAY "Example 5b passed."  
ELSE  
    DISPLAY "Example 5b failed."  
END-IF.
```

```
MOVE "RAWRXEB" TO WORD-1.  
PERFORM EXAMPLE5.  
IF WORD-1 = "RAQRYEZ"  
    DISPLAY "Example 5c passed."  
ELSE  
    DISPLAY "Example 5c failed."  
END-IF.
```

0060.

```
MOVE "12 XZABCD" TO WORD-1.  
PERFORM EXAMPLE6.  
IF WORD-1(1:9) = "BBBBBABCD"  
    DISPLAY "Example 6a passed."  
ELSE  
    DISPLAY "Example 6a failed."  
END-IF.
```

```
MOVE "123456789" TO WORD-1.  
PERFORM EXAMPLE6.  
IF WORD-1(1:9) = "BBBBBBBBB"  
    DISPLAY "Example 6b passed."  
ELSE  
    DISPLAY "Example 6b failed."  
END-IF.
```

```
MOVE "A23456789" TO WORD-1.  
PERFORM EXAMPLE6.  
IF WORD-1(1:9) = "A23456789"  
    DISPLAY "Example 6c passed."  
ELSE  
    DISPLAY "Example 6c failed."  
END-IF.
```

0070.

```
MOVE "name" TO WORD-1.
```

```
PERFORM EXAMPLE7.
IF WORD-1 = "NAME"
  DISPLAY "Example 7a passed."
ELSE
  DISPLAY "Example 7a failed."
END-IF.
```

```
MOVE "Day Count" TO WORD-1.
PERFORM EXAMPLE7.
IF WORD-1 = "DAY COUNT"
  DISPLAY "Example 7b passed."
ELSE
  DISPLAY "Example 7b failed."
END-IF.
```

0080.

```
MOVE "name" TO WORD-1.
PERFORM EXAMPLE8.
IF WORD-1 = "name#####" AND COUNT-1 = 5
  DISPLAY "Example 8a passed."
ELSE
  DISPLAY "Example 8a failed."
END-IF.
```

```
MOVE "address" TO WORD-1.
PERFORM EXAMPLE8.
IF WORD-1 = "address##" AND COUNT-1 = 2
  DISPLAY "Example 8b passed."
ELSE
  DISPLAY "Example 8b failed."
END-IF.
```

```
ACCEPT WORD-1 PROMPT "#" SIZE 1.
STOP RUN.
```

EXAMPLE1.

```
*>-----
MOVE ZERO TO COUNT-1, COUNT-2.
INSPECT WORD-1 TALLYING
  COUNT-1 FOR LEADING "L" BEFORE INITIAL "A"
  COUNT-2 FOR LEADING "A" BEFORE INITIAL "L".

*> WORD-1 = "LARGE"    -> COUNT-1 = 1, COUNT-2 = 0
*> WORD-1 = "ANALYST" -> COUNT-1 = 0, COUNT-2 = 1
*>-----
```

EXAMPLE2.

```
MOVE ZERO TO COUNT-1.
INSPECT WORD-1 TALLYING
  COUNT-1 FOR ALL "L" REPLACING
  ALL "A" BY "E" AFTER INITIAL "L".

*> WORD-1 = "CALLAR" -> COUNT-1 = 2, WORD-1 = "CALLER"
*> WORD-1 = "SALAMI" -> COUNT-1 = 1, WORD-1 = "SALEMI"
*> WORD-1 = "LATTER" -> COUNT-1 = 1, WORD-1 = "LETTER"
*>-----
```

EXAMPLE3.

```
INSPECT WORD-1 REPLACING  
ALL "A" BY "G" BEFORE INITIAL "X".
```

```
*> WORD-1 = "ARXAX" -> WORD-1 = "GRXAX"  
*> WORD-1 = "HANDAX" -> WORD-1 = "HGNDGX"  
*>-----
```

EXAMPLE4.

```
MOVE ZERO TO COUNT-1.  
INSPECT WORD-1 TALLYING  
COUNT-1 FOR CHARACTERS AFTER INITIAL "J"  
REPLACING ALL "A" BY "B".
```

```
*>-----  
*> WORD-1 = "ADJECTIVE" -> COUNT-1 = 6, WORD-1 = "BDJECTIVE"
```

```
MOVE ZERO TO COUNT-2.  
INSPECT WORD-1 TALLYING COUNT-2 FOR ALL SPACE.  
SUBTRACT COUNT-2 FROM COUNT-1.
```

```
*>-----
```

EXAMPLE5.

```
INSPECT WORD-1 REPLACING ALL "X" BY "Y",  
"B" BY "Z", "W" BY "Q" AFTER INITIAL "R".
```

```
*> WORD-1 = "RXXBQWY" -> WORD-1 = "RYYZQQY"  
*> WORD-1 = "YZACDWBR" -> WORD-1 = "YZACDWZR"  
*> WORD-1 = "RAWRXEB" -> WORD-1 = "RAQRYEZ"  
*>-----
```

EXAMPLE6.

```
INSPECT WORD-1 REPLACING CHARACTERS BY "B"  
BEFORE INITIAL "A".
```

```
*> WORD-1 = "12 XZABCD" -> WORD-1 = "BBBBBABCD"  
*> WORD-1 = "123456789" -> WORD-1 = "BBBBBBBBBB"  
*> WORD-1 = "A23456789" -> WORD-1 = "A23456789"  
*>-----
```

EXAMPLE7.

```
INSPECT WORD-1 CONVERTING  
"abcdefghijklmnopqrstuvwxyz" TO  
"ABCDEFGHIJKLMNOPQRSTUVWXYZ".
```

```
*> WORD-1 = "name" -> WORD-1 = "NAME"  
*> WORD-1 = "Day Total" -> WORD-1 = "DAY TOTAL"  
*>-----
```

EXAMPLE8.

```
MOVE ZERO TO COUNT-1.  
INSPECT WORD-1 TALLYING COUNT-1 FOR TRAILING SPACES  
REPLACING TRAILING SPACES BY "#".
```

```
*> WORD-1 = "name " -> WORD-1 = "name#####", COUNT-1 = 5  
*> WORD-1 = "address " -> WORD-1 = "address##", COUNT-1 = 2  
*>-----
```

END PROGRAM INSPECT1.

MERGE Statement Example

```
IDENTIFICATION DIVISION.
PROGRAM-ID.  MERGE01.
*
*  Examples for RM/COBOL Language Reference Manual.
*  MERGE statement.
*
ENVIRONMENT DIVISION.
INPUT-OUTPUT SECTION.
FILE-CONTROL.
    SELECT MERGE-FILE ASSIGN TO SORT-WORK.
    SELECT SORTED-FILE-1 ASSIGN TO DISK.
    SELECT SORTED-FILE-2 ASSIGN TO DISK.

DATA DIVISION.
FILE SECTION.
SD MERGE-FILE.
01 MERGE-RECORD.
    02 MERGE-KEY-1          PIC X(05) .
    02 MERGE-KEY-2          PIC 9(05) BINARY.
    02 MERGE-DATA-1         PIC X(20) .
FD SORTED-FILE-1.
01 SORTED-FILE-1-RECORD.
    02 SORTED-KEY-1         PIC X(05) .
    02 SORTED-KEY-2         PIC 9(05) BINARY.
    02 SORTED-DATA-1        PIC X(20) .
FD SORTED-FILE-2.
01 SORTED-FILE-2-RECORD.
    02 SORTED-KEY-1         PIC X(05) .
    02 SORTED-KEY-2         PIC 9(05) BINARY.
    02 SORTED-DATA-1        PIC X(20) .
WORKING-STORAGE SECTION.
01 EOF-FLAG                 PIC X(01) .
    88 EOF                   VALUE "T" WHEN FALSE "F".

PROCEDURE DIVISION.
MAIN1.
    MERGE MERGE-FILE
        ON ASCENDING KEY MERGE-KEY-1
        ON DESCENDING KEY MERGE-KEY-2
        USING SORTED-FILE-1 SORTED-FILE-2
        OUTPUT PROCEDURE IS PUT-RECORDS.
    STOP RUN.

PUT-RECORDS.
    SET EOF TO FALSE.
    PERFORM UNTIL EOF
        RETURN MERGE-FILE RECORD
        AT END SET EOF TO TRUE
        NOT AT END CALL "WRITE-RECORD" USING MERGE-RECORD
    END-RETURN
```

```
END-PERFORM.  
  
END PROGRAM MERGE01.
```

MOVE Statement Example

```
IDENTIFICATION DIVISION.  
PROGRAM-ID. MOVE01.  
*  
* Examples for RM/COBOL Language Reference Manual.  
* MOVE statement.  
*  
ENVIRONMENT DIVISION.  
INPUT-OUTPUT SECTION.  
FILE-CONTROL.  
    SELECT POPULATION-FILE ASSIGN TO DISK.  
  
DATA DIVISION.  
FILE SECTION.  
FD POPULATION-FILE.  
01 FILE-RECORD.  
    02 PERSON PIC X(30).  
WORKING-STORAGE SECTION.  
01 INCOME PIC S9(10)V99.  
01 TOTAL-INCOME PIC S9(10)V99.  
01 PAGE-COUNT PIC 9(5) BINARY.  
01 LINE-NUM PIC 9(5) BINARY.  
01 TITLE-HEADER PIC X(50).  
01 ALABAMA.  
    02 I-A PIC 9(04) BINARY.  
    02 PERSON PIC X(30)  
        OCCURS 1000 TIMES.  
01 CROSS-CENSUS.  
    02 PERSON PIC X(30).  
01 NUM PIC S9(5)V9(4).  
01 NUM-ED PIC $+(6).9(4).  
01 TG.  
    02 G1 OCCURS 5 TIMES INDEXED BY N.  
        03 G2 OCCURS 5 TIMES INDEXED BY J.  
            04 TABLE-ELT PIC X(20)  
                OCCURS 5 TIMES INDEXED BY M.  
01 NEXT-ENTRY PIC X(20).  
01 PREVIOUS-ENTRY PIC X(20).  
01 DEFICIT PIC S9(10)V99.  
01 SECTION-DIVIDER PIC X(80).  
01 COUN-TER PIC S9(8).  
PROCEDURE DIVISION.  
0010.  
    MOVE INCOME TO TOTAL-INCOME.  
  
    MOVE 1 TO PAGE-COUNT, LINE-NUM.  
  
    MOVE "Marmack Industries" to TITLE-HEADER.  
  
    MOVE PERSON IN FILE-RECORD TO
```

```
PERSON OF ALABAMA (I-A OF ALABAMA),  
PERSON OF CROSS-CENSUS.  
  
MOVE NUM TO NUM-ED.  
  
MOVE TABLE-ELT (N, 1, M) TO NEXT-ENTRY  
PREVIOUS-ENTRY.  
  
MOVE -36.7 TO DEFICIT.  
  
MOVE QUOTES TO SECTION-DIVIDER.  
  
MOVE ZERO TO COUN-TER.  
  
MOVE ZEROES TO COUN-TER, NUM, NUM-ED.  
  
END PROGRAM MOVE01.
```

MULTIPLY Statement Example

```
IDENTIFICATION DIVISION.  
PROGRAM-ID. MULTPLY1.  
*  
* Examples for RM/COBOL Language Reference Manual.  
* MULTIPLY statement.  
*  
DATA DIVISION.  
WORKING-STORAGE SECTION.  
01 INCOME PIC 9(08)V99.  
01 PRINCIPAL PIC S9(10)V99.  
01 INTEREST-RATE PIC S9(04)V9(04).  
01 INTEREST PIC S9(08)V9(02).  
01 INFLATION-RATE PIC S9(04)V9(04).  
01 EXPENSES PIC S9(10)V9(02).  
01 ECONOMY-RATING PIC S9(05).  
PROCEDURE DIVISION.  
A.  
MULTIPLY 10 BY INCOME. *> INCOME := (10 * INCOME)  
  
MULTIPLY PRINCIPAL BY INTEREST-RATE  
GIVING INTEREST ROUNDED.  
  
MULTIPLY INFLATION-RATE BY EXPENSES  
ON SIZE ERROR  
MOVE 0 TO ECONOMY-RATING  
END-MULTIPLY.  
  
END PROGRAM MULTPLY1.
```

OPEN Statement Example

```
IDENTIFICATION DIVISION.
```

OPEN Statement Example
RM/COBOL Language Examples

```
PROGRAM-ID.  OPEN01.
*
*  Examples for RM/COBOL Language Reference Manual.
*  OPEN statement.
*
ENVIRONMENT DIVISION.
INPUT-OUTPUT SECTION.
FILE-CONTROL.
    SELECT TRANSACTION-FILE  ASSIGN TO TAPE.
    SELECT LOG-FILE          ASSIGN TO DISK
                                FILE STATUS IS LOG-FILE-STATUS.

    SELECT INPUT-FILE        ASSIGN TO TAPE.
    SELECT TAPE-FILE-1       ASSIGN TO TAPE.
    SELECT PRINT-FILE        ASSIGN TO PRINTER.
    SELECT DATA-BASE        ASSIGN TO DISK
                                INDEXED ACCESS DYNAMIC
                                RECORD KEY IS DB-KEY
                                FILE STATUS IS DB-STATUS.

DATA DIVISION.
FILE SECTION.
FD TRANSACTION-FILE.
01 TR-RECORD                 PIC X(80) .

FD LOG-FILE.
01 LOG-RECORD                PIC X(80) .

FD INPUT-FILE.
01 IN-RECORD                 PIC X(80) .

FD TAPE-FILE-1.
01 TF1-RECORD                PIC X(512) .

FD PRINT-FILE.
01 PF-RECORD                 PIC X(60) .

FD DATA-BASE.
01 DB-RECORD.
    02 DB-DATA-1              PIC X(10) .
    02 DB-KEY                 PIC X(20) .
    02 DB-DATA-2              PIC X(50) .

WORKING-STORAGE SECTION.
01 LOG-FILE-STATUS           PIC X(02) .
01 DB-STATUS                  PIC X(02) .
PROCEDURE DIVISION.
DECLARATIVES.
I-O-ERROR SECTION.
    USE AFTER STANDARD EXCEPTION PROCEDURE ON I-O.
I-O-ERROR1.
    EXIT.
END DECLARATIVES.
MAIN-01 SECTION.
0010.
    OPEN EXCLUSIVE INPUT TRANSACTION-FILE.

    OPEN EXCLUSIVE OUTPUT LOG-FILE WITH NO REWIND.
```

```
OPEN I-O LOG-FILE.

OPEN EXTEND INPUT-FILE.

OPEN INPUT TAPE-FILE-1 REVERSED.

OPEN I-O DATA-BASE WITH LOCK.

OPEN INPUT DATA-BASE.

END PROGRAM OPEN01.
```

PERFORM Statement Example

```
IDENTIFICATION DIVISION.
PROGRAM-ID.  PERFORM1.
*
*  Examples for RM/COBOL Language Reference Manual.
*  PERFORM statement.
*
ENVIRONMENT DIVISION.
CONFIGURATION SECTION.
INPUT-OUTPUT SECTION.
FILE-CONTROL.
    SELECT INPUT-FILE ASSIGN TO DISK.

DATA DIVISION.
FILE SECTION.
FD INPUT-FILE.
01 INPUT-RECORD          PIC X(80) .
WORKING-STORAGE SECTION.
01 ITEM-COUNT            PIC S9(5) BINARY.
01 RECORD-COUNT          PIC S9(5) BINARY.
01 EOF-FLAG              PIC X.
    88 EOF                VALUE "T" FALSE "F".
01 G1.
    02 T1                OCCURS 100 TIMES
                        INDEXED BY T1-IX.
        03 E1-FIELD      PIC X(5) .
        03 E1-LINE       PIC 9(02) BINARY.
        03 E1-COL        PIC 9(02) BINARY.
01 COUNT-1              PIC 9(04) BINARY.
01 G2.
    02 T2                OCCURS 5 TIMES
                        INDEXED BY IX1.
        03 T3            OCCURS 10 TIMES
                        INDEXED BY IX2.
        04 E2            PIC X.

PROCEDURE DIVISION.
0010.
    PERFORM INTIALIZATION-PROCEDURE.

    PERFORM GROUP1 THROUGH GROUP5.
```

```
PERFORM
  DISPLAY "Ending run unit now"
  STOP RUN
END-PERFORM.

0020.
PERFORM STEP-UP COUNT-1 TIMES.

PERFORM 4 TIMES
  ADD ITEM-COUNT TO ITEM-COUNT
END-PERFORM.

0030.
SET EOF TO FALSE.
PERFORM UNTIL EOF
  READ INPUT-FILE
  AT END SET EOF TO TRUE
  NOT AT END ADD 1 TO RECORD-COUNT
END-READ
END-PERFORM.

PERFORM ITEM-PROCEDURE
  WITH TEST AFTER UNTIL ITEM-COUNT = 0.

0040.
PERFORM VARYING T1-IX FROM 1 BY 1
  UNTIL T1-IX > 100
  DISPLAY E1-FIELD(T1-IX)
  LINE  E1-LINE(T1-IX)
  COL   E1-COL(T1-IX)
END-PERFORM.

PERFORM TABLE-INITIALIZE
  VARYING IX1 FROM 1 BY 1 UNTIL IX1 > 5
  AFTER  IX2 FROM 1 BY 1 UNTIL IX2 > 10.

INITIALIZATION-PROCEDURE.
GROUP1.
GROUP2.
GROUP3.
GROUP4.
GROUP5.
ITEM-PROCEDURE.
STEP-UP.
TABLE-INITIALIZE.

END PROGRAM PERFORM1.
```

PURGE Statement Example

```
IDENTIFICATION DIVISION.
PROGRAM-ID.  PURGE1.
*
* Examples for RM/COBOL Language Reference Manual.
* PURGE statement.
```

```
*
DATA DIVISION.
WORKING-STORAGE SECTION.
COMMUNICATION SECTION.
CD COM-LINE-1 FOR OUTPUT
    DESTINATION COUNT IS L1-DEST-COUNT
    TEXT LENGTH IS L1-TEXT-LENGTH
    STATUS KEY IS L1-STATUS-KEY
    DESTINATION TABLE OCCURS 5 TIMES
        INDEXED BY L1IX1, L1IX2
    ERROR KEY IS L1-ERROR-KEY
    SYMBOLIC DESTINATION IS L1-SYM-DEST.

CD COM-LINE-2 FOR I-O
    SYMBOLIC TERMINAL IS COM-L2-TERMINAL-NAME
    MESSAGE DATE IS COM-L2-MSG-DT
    MESSAGE TIME IS COM-L2-MSG-TM
    TEXT LENGTH IS COM-L2-TXT-LENGTH
    END KEY IS COM-L2-END-KEY
    STATUS KEY IS COM-L2-STATUS-KEY.

PROCEDURE DIVISION.
0010.

    PURGE COM-LINE-1.

    PURGE COM-LINE-2.

END PROGRAM PURGE1.
```

READ Statement Examples

READ Format 1

```
IDENTIFICATION DIVISION.
PROGRAM-ID.  READ01.
*
*  Examples for RM/COBOL Language Reference Manual.
*  READ statement (sequential access).
*
ENVIRONMENT DIVISION.
INPUT-OUTPUT SECTION.
FILE-CONTROL.
    SELECT TRANSACTION-FILE ASSIGN TO TAPE.
    SELECT LOG-FILE        ASSIGN TO DISK
                            FILE STATUS IS LOG-FILE-STATUS.
    SELECT INPUT-FILE      ASSIGN TO TAPE.
    SELECT TAPE-FILE-1    ASSIGN TO TAPE.
    SELECT INVENTORY-FILE ASSIGN TO DISK
                            RELATIVE ACCESS DYNAMIC
                                RELATIVE KEY IS
                                    INVENTORY-KEY.
    SELECT DATA-BASE     ASSIGN TO DISK
```

READ Statement Examples
RM/COBOL Language Examples

```
INDEXED ACCESS DYNAMIC
RECORD KEY IS DB-KEY
FILE STATUS IS DB-STATUS.

DATA DIVISION.
FILE SECTION.
FD TRANSACTION-FILE.
01 TR-RECORD          PIC X(80) .

FD LOG-FILE.
01 LOG-RECORD        PIC X(80) .

FD INPUT-FILE.
01 IN-RECORD         PIC X(80) .

FD TAPE-FILE-1.
01 TF1-RECORD       PIC X(512) .

FD INVENTORY-FILE.
01 INVENTORY-RECORD PIC X(80) .

FD DATA-BASE.
01 DB-RECORD.
   02 DB-DATA-1     PIC X(10) .
   02 DB-KEY        PIC X(20) .
   02 DB-DATA-2     PIC X(50) .

WORKING-STORAGE SECTION.
01 LOG-FILE-STATUS  PIC X(02) .
01 DB-STATUS        PIC X(02) .
01 INVENTORY-KEY    PIC 9(05) BINARY.
01 RECORD-SAVE      PIC X(80) .
01 EOF-FLAG         PIC X.
   88 EOF           VALUE "T" FALSE "F" .

PROCEDURE DIVISION.
DECLARATIVES.
I-O-ERROR SECTION.
   USE AFTER STANDARD EXCEPTION PROCEDURE ON I-O.
I-O-ERROR1.
   EXIT.
END DECLARATIVES.
MAIN-01 SECTION.
0010.
   READ TRANSACTION-FILE RECORD.

   READ LOG-FILE NEXT RECORD INTO RECORD-SAVE
   AT END SET EOF TO TRUE
   NOT AT END PERFORM PROCESS-LOG-RECORD
   END-READ.

   READ INVENTORY-FILE PREVIOUS RECORD WITH LOCK
   AT END DISPLAY "Beginning-of-file reached."
   END-READ.

   READ DATA-BASE NEXT RECORD WITH NO LOCK
   AT END PERFORM EOF-PROCEDURE.
```



```
PROCESS-LOG-RECORD.  
EOF-PROCEDURE.  
  
END PROGRAM READ01.
```

READ Format 2

```
IDENTIFICATION DIVISION.  
PROGRAM-ID. READ02.  
*  
* Examples for RM/COBOL Language Reference Manual.  
* READ statement (random access).  
*  
ENVIRONMENT DIVISION.  
INPUT-OUTPUT SECTION.  
FILE-CONTROL.  
    SELECT INVENTORY-FILE      ASSIGN TO DISK  
                                RELATIVE ACCESS RANDOM  
                                RELATIVE KEY IS  
                                INVENTORY-KEY.  
    SELECT DATA-BASE          ASSIGN TO DISK  
                                INDEXED ACCESS DYNAMIC  
                                RECORD KEY IS DB-KEY  
                                FILE STATUS IS DB-STATUS.  
  
DATA DIVISION.  
FILE SECTION.  
FD INVENTORY-FILE.  
01 INVENTORY-RECORD          PIC X(80).  
  
FD DATA-BASE.  
01 DB-RECORD.  
    02 DB-DATA-1              PIC X(10).  
    02 DB-KEY                  PIC X(20).  
    02 DB-DATA-2              PIC X(50).  
  
WORKING-STORAGE SECTION.  
01 INVENTORY-KEY              PIC 9(05) BINARY.  
01 DB-STATUS                  PIC X(02).  
01 RECORD-WORK-AREA          PIC X(80).  
PROCEDURE DIVISION.  
DECLARATIVES.  
I-O-ERROR SECTION.  
    USE AFTER STANDARD EXCEPTION PROCEDURE ON I-O.  
I-O-ERROR1.  
    EXIT.  
END DECLARATIVES.  
MAIN-01 SECTION.  
0010.  
    READ INVENTORY-FILE RECORD  
    INVALID KEY PERFORM BAD-KEY-PROCEDURE  
    END-READ.  
  
    READ DATA-BASE WITH NO LOCK INTO RECORD-WORK-AREA  
    INVALID KEY DISPLAY "Bad key"  
    NOT INVALID KEY PERFORM PROCESS-WORK-AREA  
    END-READ.
```

```
BAD-KEY-PROCEDURE.  
PROCESS-WORK-AREA.  
  
END PROGRAM READ02.
```

RECEIVE Statement Example

```
IDENTIFICATION DIVISION.  
PROGRAM-ID. RECEIVE1.  
*  
* Examples for RM/COBOL Language Reference Manual.  
* RECEIVE statement.  
*  
DATA DIVISION.  
WORKING-STORAGE SECTION.  
01 MESSAGE-BUFFER PIC X(1000).  
01 SEGMENT-BUFFER PIC X(500).  
01 DEFAULT-SEGMENT PIC X(500).  
COMMUNICATION SECTION.  
CD COM-PORT FOR INPUT  
    SYMBOLIC QUEUE IS COM-PORT-SYMQ  
    SYMBOLIC SUB-QUEUE-1 IS COM-PORT-SYM-SUBQ1  
    SYMBOLIC SUB-QUEUE-2 IS COM-PORT-SYM-SUBQ2  
    SYMBOLIC SUB-QUEUE-3 IS COM-PORT-SYM-SUBQ3  
    MESSAGE DATE IS COM-PORT-MSG-DT  
    MESSAGE TIME IS COM-PORT-MSG-TM  
    SYMBOLIC SOURCE IS COM-PORT-SYM-SRC  
    TEXT LENGTH IS COM-PORT-TXT-LENGTH  
    END KEY IS COM-PORT-END-KEY  
    STATUS KEY IS COM-PORT-STATUS-KEY  
    MESSAGE COUNT IS COM-PORT-MSG-COUNT.  
  
CD COM-LINE-2 FOR I-O  
    SYMBOLIC TERMINAL IS COM-L2-TERMINAL-NAME  
    MESSAGE DATE IS COM-L2-MSG-DT  
    MESSAGE TIME IS COM-L2-MSG-TM  
    TEXT LENGTH IS COM-L2-TXT-LENGTH  
    END KEY IS COM-L2-END-KEY  
    STATUS KEY IS COM-L2-STATUS-KEY.  
  
PROCEDURE DIVISION.  
0010.  
  
    RECEIVE COM-PORT MESSAGE INTO MESSAGE-BUFFER  
    NO DATA PERFORM NO-MESSAGE-PROCEDURE  
    WITH DATA PERFORM PROCESS-MESSAGE-PROCEDURE  
    END-RECEIVE.  
  
    RECEIVE COM-LINE-2 SEGMENT INTO SEGMENT-BUFFER  
    NO DATA MOVE  
    DEFAULT-SEGMENT TO SEGMENT-BUFFER  
    END-RECEIVE.  
  
NO-MESSAGE-PROCEDURE.
```

```
PROCESS-MESSAGE-PROCEDURE.  
  
END PROGRAM RECEIVE1.
```

RELEASE Statement Example

```
IDENTIFICATION DIVISION.  
PROGRAM-ID.  RELEASE1.  
*  
*  Examples for RM/COBOL Language Reference Manual.  
*  RELEASE statement.  
*  
ENVIRONMENT DIVISION.  
INPUT-OUTPUT SECTION.  
FILE-CONTROL.  
    SELECT SORT-FILE ASSIGN TO SORT-WORK.  
    SELECT SORTED-FILE-1 ASSIGN TO DISK.  
    SELECT INPUT-FILE ASSIGN TO DISK.  
  
DATA DIVISION.  
FILE SECTION.  
SD SORT-FILE.  
01 SORT-RECORD.  
    02 SORT-KEY-1          PIC X(05).  
    02 SORT-KEY-2          PIC 9(05) BINARY.  
    02 SORT-DATA-1        PIC X(20).  
FD SORTED-FILE-1.  
01 SORTED-FILE-1-RECORD.  
    02 SORTED-KEY-1        PIC X(05).  
    02 SORTED-KEY-2        PIC 9(05) BINARY.  
    02 SORTED-DATA-1      PIC X(20).  
FD INPUT-FILE.  
01 INPUT-RECORD.  
    02 INPUT-KEY-1         PIC X(05).  
    02 INPUT-KEY-2         PIC 9(05) BINARY.  
    02 INPUT-DATA-1       PIC X(20).  
WORKING-STORAGE SECTION.  
01 INPUT-EOF-FLAG         PIC X.  
    88 INPUT-EOF          VALUE "T" FALSE "F".  
  
PROCEDURE DIVISION.  
MAIN1.  
    SORT SORT-FILE  
        ON ASCENDING KEY SORT-KEY-1  
        ON DESCENDING KEY SORT-KEY-2  
        INPUT PROCEDURE IS SORT-INPUT-PROCEDURE  
        GIVING SORTED-FILE-1.  
    STOP RUN.  
  
SORT-INPUT-PROCEDURE.  
    SET INPUT-EOF TO FALSE.  
    OPEN INPUT INPUT-FILE.  
    PERFORM UNTIL INPUT-EOF  
        READ INPUT-FILE AT END  
        SET INPUT-EOF TO TRUE
```

```
NOT AT END
  RELEASE SORT-RECORD FROM INPUT-RECORD
END-READ
END-PERFORM.
CLOSE INPUT-FILE.
END PROGRAM RELEASE1.
```

RETURN Statement Example

```
IDENTIFICATION DIVISION.
PROGRAM-ID.  RETURN01.
*
*  Examples for RM/COBOL Language Reference Manual.
*  RETURN statement.
*
ENVIRONMENT DIVISION.
INPUT-OUTPUT SECTION.
FILE-CONTROL.
  SELECT SORT-FILE ASSIGN TO SORT-WORK.
  SELECT OUTPUT-FILE ASSIGN TO DISK.
  SELECT INPUT-FILE ASSIGN TO DISK.

DATA DIVISION.
FILE SECTION.
SD SORT-FILE.
01 SORT-RECORD.
  02 SORT-KEY-1          PIC X(05).
  02 SORT-KEY-2          PIC 9(05) BINARY.
  02 SORT-DATA-1        PIC X(20).
FD OUTPUT-FILE.
01 OUTPUT-RECORD.
  02 OUTPUT-KEY-1       PIC X(05).
  02 OUTPUT-KEY-2       PIC 9(05) BINARY.
  02 OUTPUT-DATA-1     PIC X(20).
FD INPUT-FILE.
01 INPUT-RECORD.
  02 INPUT-KEY-1        PIC X(05).
  02 INPUT-KEY-2        PIC 9(05) BINARY.
  02 INPUT-DATA-1       PIC X(20).
WORKING-STORAGE SECTION.
01 INPUT-EOF-FLAG       PIC X.
  88 INPUT-EOF          VALUE "T" FALSE "F".
01 SORT-EOF-FLAG        PIC X.
  88 SORT-EOF           VALUE "T" FALSE "F".

PROCEDURE DIVISION.
MAIN1.
  SORT SORT-FILE
  ON ASCENDING KEY SORT-KEY-1
  ON DESCENDING KEY SORT-KEY-2
  INPUT PROCEDURE IS SORT-INPUT-PROCEDURE
  OUTPUT PROCEDURE IS SORT-MERGE-OUTPUT-PROCEDURE.
  STOP RUN.

SORT-MERGE-OUTPUT-PROCEDURE.
```

```
OPEN OUTPUT OUTPUT-FILE.
SET SORT-EOF TO FALSE.
PERFORM UNTIL SORT-EOF
    RETURN SORT-FILE RECORD INTO OUTPUT-RECORD
    AT END SET SORT-EOF TO TRUE
    NOT AT END
        WRITE OUTPUT-RECORD
    END-RETURN
END-PERFORM.
CLOSE OUTPUT-FILE.

SORT-INPUT-PROCEDURE.
SET INPUT-EOF TO FALSE.
OPEN INPUT INPUT-FILE.
PERFORM UNTIL INPUT-EOF
    READ INPUT-FILE AT END
        SET INPUT-EOF TO TRUE
    NOT AT END
        RELEASE SORT-RECORD FROM INPUT-RECORD
    END-READ
END-PERFORM.
CLOSE INPUT-FILE.

END PROGRAM RETURN01.
```

REWRITE Statement Example

IDENTIFICATION DIVISION.
PROGRAM-ID. REWRITE01.

*

* Examples for RM/COBOL Language Reference Manual.

* REWRITE statement.

*

ENVIRONMENT DIVISION.
INPUT-OUTPUT SECTION.
FILE-CONTROL.

```
    SELECT LOG-FILE          ASSIGN TO DISK
                             FILE STATUS IS LOG-FILE-STATUS.
```

```
    SELECT INVENTORY-FILE    ASSIGN TO DISK
                             RELATIVE ACCESS RANDOM
                             RELATIVE KEY IS INVENTORY-KEY.
```

```
    SELECT DATA-BASE        ASSIGN TO DISK
                             INDEXED ACCESS DYNAMIC
                             RECORD KEY IS DB-KEY
                             FILE STATUS IS DB-STATUS.
```

DATA DIVISION.
FILE SECTION.

```
FD LOG-FILE.
01 LOG-RECORD                PIC X(80).
```

```
FD INVENTORY-FILE.
01 INVENTORY-RECORD         PIC X(80).
```

```
FD DATA-BASE.
01 DB-RECORD.
   02 DB-DATA-1          PIC X(10).
   02 DB-KEY            PIC X(20).
   02 DB-DATA-2        PIC X(50).

WORKING-STORAGE SECTION.
01 LOG-FILE-STATUS     PIC X(02).
01 INVENTORY-KEY      PIC 9(5) BINARY.
01 DB-STATUS          PIC X(02).
PROCEDURE DIVISION.
DECLARATIVES.
I-O-ERROR SECTION.
   USE AFTER STANDARD EXCEPTION PROCEDURE ON I-O.
I-O-ERROR1.
   EXIT.
END DECLARATIVES.
MAIN-01 SECTION.
0010.
   REWRITE LOG-RECORD OF LOG-FILE.

   REWRITE LOG-RECORD FROM "END-OF-BATCH"
   END-REWRITE.

   REWRITE INVENTORY-RECORD
   INVALID KEY PERFORM INVALID-KEY-HANDLER
   END-REWRITE.

   REWRITE DB-RECORD OF DATA-BASE
   INVALID KEY
   REWRITE INVENTORY-RECORD END-REWRITE
   END-REWRITE.

INVALID-KEY-HANDLER.

END PROGRAM REWRITE01.
```

SEARCH Statement Example

```
IDENTIFICATION DIVISION.
PROGRAM-ID. SEARCH01.
*
* Examples for RM/COBOL Language Reference Manual.
* SEARCH statement.
*
ENVIRONMENT DIVISION.
CONFIGURATION SECTION.
OBJECT-COMPUTER. RMCOBOL
   PROGRAM COLLATING SEQUENCE IS CASE-INSENSITIVE.
SPECIAL-NAMES.
   ALPHABET CASE-INSENSITIVE IS 1 THRU 32,
   SPACE ALSO " ", 34 THRU 65,
   "A" ALSO "a", "B" ALSO "b", "C" ALSO "c", "D" ALSO "d",
   "E" ALSO "e", "F" ALSO "f", "G" ALSO "g", "H" ALSO "h",
```

"I" ALSO "i", "J" ALSO "j", "K" ALSO "k", "L" ALSO "l",
 "M" ALSO "m", "N" ALSO "n", "O" ALSO "o", "P" ALSO "p",
 "Q" ALSO "q", "R" ALSO "r", "S" ALSO "s", "T" ALSO "t",
 "U" ALSO "u", "V" ALSO "v", "W" ALSO "w", "X" ALSO "x",
 "Y" ALSO "y", "Z" ALSO "z", 92 THRU 95, 97, 124 THRU 128.

DATA DIVISION.

WORKING-STORAGE SECTION.

01 STATE-GROUP.

02 STATE-NAME-VALUES.

03 PIC X(34)	VALUE "AK: Alaska	Juneau	".
03 PIC X(34)	VALUE "AL: Alabama	Montgomery	".
03 PIC X(34)	VALUE "AR: Arkansas	Little_Rock	".
03 PIC X(34)	VALUE "AZ: Arizona	Phoenix	".
03 PIC X(34)	VALUE "CA: California	Sacramento	".
03 PIC X(34)	VALUE "CN: Connecticut	Hartford	".
03 PIC X(34)	VALUE "CO: Colorado	Denver	".
03 PIC X(34)	VALUE "DE: Delaware	Dover	".
03 PIC X(34)	VALUE "FL: Florida	Tallahassee	".
03 PIC X(34)	VALUE "GA: Georgia	Atlanta	".
03 PIC X(34)	VALUE "HI: Hawaii	Honolulu	".
03 PIC X(34)	VALUE "IA: Iowa	Des_Moines	".
03 PIC X(34)	VALUE "ID: Idaho	Boise	".
03 PIC X(34)	VALUE "IL: Illinois	Springfield	".
03 PIC X(34)	VALUE "IN: Indiana	Indianapolis	".
03 PIC X(34)	VALUE "KS: Kansas	Topeka	".
03 PIC X(34)	VALUE "KY: Kentucky	Frankfort	".
03 PIC X(34)	VALUE "LA: Louisiana	Baton_Rouge	".
03 PIC X(34)	VALUE "MA: Massachusetts	Boston	".
03 PIC X(34)	VALUE "MD: Maryland	Annapolis	".
03 PIC X(34)	VALUE "ME: Maine	Augusta	".
03 PIC X(34)	VALUE "MI: Michigan	Lansing	".
03 PIC X(34)	VALUE "MN: Minnesota	St._Paul	".
03 PIC X(34)	VALUE "MO: Missouri	Jefferson_City"	".
03 PIC X(34)	VALUE "MS: Mississippi	Jackson	".
03 PIC X(34)	VALUE "MT: Montana	Helena	".
03 PIC X(34)	VALUE "NC: North_Carolina	Raleigh	".
03 PIC X(34)	VALUE "ND: North_Dakota	Bismarck	".
03 PIC X(34)	VALUE "NE: Nebraska	Lincoln	".
03 PIC X(34)	VALUE "NH: New_Hampshire	Concord	".
03 PIC X(34)	VALUE "NJ: New_Jersey	Trenton	".
03 PIC X(34)	VALUE "NM: New_Mexico	Santa_Fe	".
03 PIC X(34)	VALUE "NV: Nevada	Carson_City	".
03 PIC X(34)	VALUE "NY: New_York	Albany	".
03 PIC X(34)	VALUE "OH: Ohio	Columbus	".
03 PIC X(34)	VALUE "OK: Oklahoma	Oklahoma_City	".
03 PIC X(34)	VALUE "OR: Oregon	Salem	".
03 PIC X(34)	VALUE "PA: Pennsylvania	Harrisburg	".
03 PIC X(34)	VALUE "RI: Rhode_Island	Providence	".
03 PIC X(34)	VALUE "SC: South_Carolina	Columbia	".
03 PIC X(34)	VALUE "SD: South_Dakota	Pierre	".
03 PIC X(34)	VALUE "TN: Tennessee	Nashville	".
03 PIC X(34)	VALUE "TX: Texas	Austin	".
03 PIC X(34)	VALUE "UT: Utah	Salt_Lake_City"	".
03 PIC X(34)	VALUE "VA: Virginia	Richmond	".
03 PIC X(34)	VALUE "VT: Vermont	Montpelier	".
03 PIC X(34)	VALUE "WA: Washington	Olympia	".
03 PIC X(34)	VALUE "WI: Wisconsin	Madison	".

SEARCH Statement Example
RM/COBOL Language Examples

```

03 PIC X(34) VALUE "WV: West_Virginia Charleston ".
03 PIC X(34) VALUE "WY: Wyoming Cheyenne ".
02 STATE-NAME-TABLE REDEFINES STATE-NAME-VALUES
                     OCCURS 50 TIMES
                     ASCENDING KEY IS STATE-ABBREV
                     INDEXED BY IX1.
03 STATE-ABBREV PIC X(02).
03 PIC X(02).
03 STATE-NAME PIC X(14).
03 PIC X(02).
03 STATE-CAPITAL PIC X(14).
01 CURR-ABBREV PIC X(02).
01 PREV-ABBREV PIC X(02).
01 INPUT-NAME PIC X(14).
01 CAPITAL-BUFFER PIC X(20).
01 STATE-BUFFER PIC X(14).
01 CAPITAL-COUNT PIC 9(04) BINARY.
01 STATE-COUNT PIC 9(04) BINARY.
01 DUMMY PIC X.
PROCEDURE DIVISION.
0010.
* Verify OCCURS key in ascending order as required for SEARCH ALL.
MOVE SPACES TO PREV-ABBREV.
PERFORM VARYING IX1 FROM 1 BY 1 UNTIL IX1 > 50
MOVE STATE-ABBREV(IX1) TO CURR-ABBREV
IF CURR-ABBREV > PREV-ABBREV
MOVE CURR-ABBREV TO PREV-ABBREV
ELSE
DISPLAY "State abbreviation out of order: "
CURR-ABBREV " < " PREV-ABBREV
ACCEPT DUMMY PROMPT "#"
STOP RUN
END-IF
END-PERFORM.

0020.
* Use serial search on unsorted STATE-NAME or STATE-CAPITAL
* and also on sorted STATE-ABBREV.
ACCEPT INPUT-NAME TAB PROMPT.
SET IX1 TO 1.
SEARCH STATE-NAME-TABLE VARYING IX1
AT END
DISPLAY "The name "" INPUT-NAME
"" is not in the state name table."
WHEN STATE-NAME(IX1) = INPUT-NAME
PERFORM SETUP-BUFFERS *> Note: uses current IX1 setting.
DISPLAY "The abbreviation for the state of ""
STATE-BUFFER(1:STATE-COUNT)
"" is "" STATE-ABBREV(IX1) "","
"and the state capital is "" COL 5
CAPITAL-BUFFER
WHEN STATE-CAPITAL(IX1) = INPUT-NAME
PERFORM SETUP-BUFFERS *> Note: uses current IX1 setting.
DISPLAY
"The city "" CAPITAL-BUFFER(1:CAPITAL-COUNT)
" is the state capital of ""
STATE-BUFFER(1:STATE-COUNT) ""."

```



```
WHEN STATE-ABBREV(IX1) = INPUT-NAME
  PERFORM SETUP-BUFFERS   *> Note: uses current IX1 setting.
  DISPLAY "The abbreviation "" STATE-ABBREV(IX1)
  "" stands for the state of ""
  STATE-BUFFER(1:STATE-COUNT) "", "
  " and the state capital is "" COL 5 CAPITAL-BUFFER
END-SEARCH.

0030.
* Use binary search on sorted STATE-ABBREV.
ACCEPT CURR-ABBREV TAB PROMPT.
SEARCH ALL STATE-NAME-TABLE
AT END
  DISPLAY "The abbreviation "" CURR-ABBREV
  "" is not in the state name table."
WHEN STATE-ABBREV(IX1) = CURR-ABBREV
  PERFORM SETUP-BUFFERS   *> Note: uses current IX1 setting.
  DISPLAY "The abbreviation "" STATE-ABBREV(IX1)
  "" stands for the state of ""
  STATE-BUFFER(1:STATE-COUNT) "", "
  " and the state capital is "" COL 5 CAPITAL-BUFFER
END-SEARCH.

GO TO 0020.

SETUP-BUFFERS.
MOVE SPACES TO CAPITAL-BUFFER.
STRING STATE-CAPITAL(IX1) DELIMITED BY SPACES,
      ", " STATE-ABBREV(IX1) ""." DELIMITED BY SIZE
  INTO CAPITAL-BUFFER.
MOVE ZERO TO CAPITAL-COUNT.
INSPECT CAPITAL-BUFFER TALLYING CAPITAL-COUNT
  FOR CHARACTERS BEFORE INITIAL "."
  REPLACING ALL "_" BY SPACE.

MOVE STATE-NAME(IX1) TO STATE-BUFFER.
MOVE ZERO TO STATE-COUNT.
INSPECT STATE-BUFFER TALLYING STATE-COUNT
  FOR CHARACTERS BEFORE INITIAL SPACE
  REPLACING ALL "_" BY SPACE.

END PROGRAM SEARCH01.
```

SEND Statement Example

```
IDENTIFICATION DIVISION.
PROGRAM-ID. SEND01.
*
* Examples for RM/COBOL Language Reference Manual.
* SEND statement.
*
DATA DIVISION.
WORKING-STORAGE SECTION.
01 MESSAGE-BUFFER          PIC X(1000).
01 SEGMENT-BUFFER         PIC X(500).
```

```
COMMUNICATION SECTION.
CD COM-LINE-1 FOR OUTPUT
  DESTINATION COUNT IS L1-DEST-COUNT
  TEXT LENGTH IS L1-TEXT-LENGTH
  STATUS KEY IS L1-STATUS-KEY
  DESTINATION TABLE OCCURS 5 TIMES
    INDEXED BY L1IX1, L1IX2
  ERROR KEY IS L1-ERROR-KEY
  SYMBOLIC DESTINATION IS L1-SYM-DEST.

CD COM-LINE-2 FOR I-O
  SYMBOLIC TERMINAL IS COM-L2-TERMINAL-NAME
  MESSAGE DATE IS COM-L2-MSG-DT
  MESSAGE TIME IS COM-L2-MSG-TM
  TEXT LENGTH IS COM-L2-TXT-LENGTH
  END KEY IS COM-L2-END-KEY
  STATUS KEY IS COM-L2-STATUS-KEY.

PROCEDURE DIVISION.
0010.

    SEND COM-LINE-1 FROM "Enter your PIN: ".

    SEND COM-LINE-2 FROM SEGMENT-BUFFER WITH ESI
      AFTER ADVANCING 3 LINES.

END PROGRAM SEND01.
```

SET Statement Example

```
IDENTIFICATION DIVISION.
PROGRAM-ID. SET01.
*
* Examples for RM/COBOL Language Reference Manual.
* SET statement.
*
ENVIRONMENT DIVISION.
CONFIGURATION SECTION.
SPECIAL-NAMES.
    SWITCH-1 IS SUMMARY-SWITCH,
    SWITCH-2 IS DETAIL-SWITCH.

DATA DIVISION.
WORKING-STORAGE SECTION.
01 G1.
    02 T1                                OCCURS 100 TIMES
        INDEXED BY IX1, IX2, IX3, IX4.
        03 E1                            PIC X(5).
01 SUB1                                PIC 9(5) BINARY.
01 EOF-FLAG                            PIC X.
    88 EOF                                VALUE "T" FALSE "F".
01 COND-1-FLAG                          PIC X.
    88 COND-1                            VALUE "A" WHEN FALSE SPACE.
01 P1                                    POINTER.
01 P2                                    POINTER.
```

```
01 COUNT-1                PIC 9(5) BINARY.
LINKAGE SECTION.
01 BL-RECORD.
    02 BL-FIELD-1         PIC X(10).
    02 BL-FIELD-2         PIC X(20).
PROCEDURE DIVISION.
0010.

    SET IX1 IX2 TO IX3, IX3 IX4 TO SUB1.

0020.

    SET IX1 IX2 UP BY 1, IX3 IX4 DOWN BY 2.

0030.

    SET SUMMARY-SWITCH TO OFF, DETAIL-SWITCH TO ON.

0040.

    SET EOF TO TRUE, COND-1 TO FALSE.

0050.

    SET P1 TO P2.

    SET ADDRESS OF BL-RECORD TO P1.

    SET P1 TO ADDRESS OF G1.
    SET P2 TO NULL.

0060.

    SET P1 UP BY LENGTH OF T1(1).

    SET ADDRESS OF BL-RECORD DOWN BY COUNT-1.

END PROGRAM SET01.
```

SORT Statement Example

```
IDENTIFICATION DIVISION.
PROGRAM-ID.  SORT01.
*
*  Examples for RM/COBOL Language Reference Manual.
*  SORT statement.
*
ENVIRONMENT DIVISION.
INPUT-OUTPUT SECTION.
FILE-CONTROL.
    SELECT SORT-FILE ASSIGN TO SORT-WORK.

DATA DIVISION.
FILE SECTION.
SD SORT-FILE.
```

START Statement Example
RM/COBOL Language Examples

```
01 SORT-RECORD.
  02 SORT-KEY-1          PIC X(05).
  02 SORT-DATA-1        PIC X(20).
  02 SORT-KEY-2          PIC 9(05) BINARY.
WORKING-STORAGE SECTION.
01 EOF-FLAG              PIC X.
  88 EOF                  VALUE "T" FALSE "F".

PROCEDURE DIVISION.
MAIN1.
  SORT SORT-FILE
    ON ASCENDING KEY SORT-KEY-1
    ON DESCENDING KEY SORT-KEY-2
    WITH DUPLICATES IN ORDER
    INPUT PROCEDURE IS GET-RECORDS
    OUTPUT PROCEDURE IS PUT-RECORDS.
  STOP RUN.

GET-RECORDS.
  PERFORM WITH TEST AFTER UNTIL EOF
    CALL "READ-RECORD" USING SORT-RECORD, EOF-FLAG
    IF NOT EOF
      RELEASE SORT-RECORD
    END-IF
  END-PERFORM.

PUT-RECORDS.
  SET EOF TO FALSE.
  PERFORM UNTIL EOF
    RETURN SORT-FILE RECORD
    AT END SET EOF TO TRUE
    NOT AT END
      CALL "WRITE-RECORD" USING SORT-RECORD
    END-RETURN
  END-PERFORM.

END PROGRAM SORT01.
```

START Statement Example

```
IDENTIFICATION DIVISION.
PROGRAM-ID.  START01.
*
*  Examples for RM/COBOL Language Reference Manual.
*  START statement (relative and indexed I-O).
*
ENVIRONMENT DIVISION.
INPUT-OUTPUT SECTION.
FILE-CONTROL.
  SELECT INVENTORY-FILE          ASSIGN TO DISK
                                RELATIVE ACCESS DYNAMIC
                                RELATIVE KEY IS INVENTORY-KEY.

  SELECT DATA-BASE              ASSIGN TO DISK
                                INDEXED ACCESS DYNAMIC
```

```
RECORD KEY IS DB-KEY
FILE STATUS IS DB-STATUS.

SELECT STATUS-FILE          ASSIGN TO DISK
                             RELATIVE ACCESS DYNAMIC
                             RELATIVE KEY IS SF-KEY.

DATA DIVISION.
FILE SECTION.
FD INVENTORY-FILE.
01 INVENTORY-RECORD        PIC X(80) .

FD DATA-BASE.
01 DB-RECORD.
   02 DB-DATA-1            PIC X(10) .
   02 DB-KEY               PIC X(20) .
   02 DB-DATA-2            PIC X(50) .

FD STATUS-FILE.
01 STATUS-RECORD          PIC X(1) .

WORKING-STORAGE SECTION.
01 DB-STATUS              PIC X(02) .
01 DB-START-KEY           PIC X(20) .
01 INVENTORY-KEY          PIC 9(5) BINARY.
01 SF-KEY                 PIC 9(5) BINARY.
01 STATUS-START-KEY      PIC 9(5) BINARY.

PROCEDURE DIVISION.
DECLARATIVES.
I-O-ERROR SECTION.
    USE AFTER STANDARD EXCEPTION PROCEDURE ON I-O.
I-O-ERROR1.
    EXIT.
END DECLARATIVES.
MAIN-01 SECTION.
0010.

    MOVE 10 TO INVENTORY-KEY.
    START INVENTORY-FILE; INVALID KEY
        DISPLAY "Key 10 not present in inventory file."
    NOT INVALID KEY
        DISPLAY "Key 10 present in inventory file."
    END-START.

    START STATUS-FILE KEY IS LAST SF-KEY.

    MOVE DB-START-KEY TO DB-KEY.
    START DATA-BASE KEY >= DB-KEY SIZE 10
    INVALID KEY PERFORM DB-INVALID-KEY-HANDLER
    NOT INVALID KEY PERFORM DB-SUCCESS-HANDLER
    END-START.

    *> set filter for finding all keys ending in
    *> "smith" (case insensitively)
    START DATA-BASE WHILE KEY LIKE ".*smith".

BAD-KEY-PROCEDURE.
```

```
EXIT.  
  
DB-SUCCESS-HANDLER.  
    EXIT.  
  
DB-INVALID-KEY-HANDLER.  
    EXIT.  
  
END PROGRAM START01.
```

STOP Statement Example

```
IDENTIFICATION DIVISION.  
PROGRAM-ID.  STOP01.  
*  
*  Examples for RM/COBOL Language Reference Manual.  
*  STOP statement.  
*  
ENVIRONMENT DIVISION.  
CONFIGURATION SECTION.  
  
DATA DIVISION.  
WORKING-STORAGE SECTION.  
01 STATUS-CODE          PIC 9(5) BINARY.  
PROCEDURE DIVISION.  
0010.  
    STOP RUN.  
  
0020.  
    STOP RUN 1.  
  
0030.  
    STOP RUN STATUS-CODE.  
  
0040.  
    STOP "End of Procedure."  
  
END PROGRAM STOP01.
```

STRING Statement Example

```
IDENTIFICATION DIVISION.  
PROGRAM-ID.  STRING01.  
*  
*  Examples for RM/COBOL Language Reference Manual.  
*  STRING statement.  
*  
ENVIRONMENT DIVISION.  
CONFIGURATION SECTION.  
  
DATA DIVISION.  
WORKING-STORAGE SECTION.
```

```
01 FIELD-1          PIC X(10) VALUE "Fred".
01 FIELD-2          PIC X(10) VALUE "T.".
01 FIELD-GROUP      PIC X(30).
01 MONTH-VALUE      PIC X(10) VALUE "March".
01 DAY-VALUE        PIC 9(02) VALUE 3.
01 YEAR-VALUE       PIC 9(04) VALUE 1999.
01 TITLE-RECORD     PIC X(70) VALUE SPACES.
01 COLUMN-CURSOR    PIC 9(04) BINARY VALUE 5.
PROCEDURE DIVISION.
0010.
    STRING FIELD-1 DELIMITED BY SPACES
        ";" DELIMITED BY SIZE
        FIELD-2 DELIMITED BY "."
        ";" DELIMITED BY SIZE
    INTO FIELD-GROUP
    ON OVERFLOW
        DISPLAY "Overflow error."
    STOP RUN
    END-STRING.

0020.
    STRING MONTH-VALUE DELIMITED BY SPACES
        SPACE DAY-VALUE "," YEAR-VALUE
        DELIMITED BY SIZE
    INTO TITLE-RECORD
    WITH POINTER COLUMN-CURSOR.

    DISPLAY FIELD-GROUP.
    DISPLAY TITLE-RECORD.
    ACCEPT FIELD-GROUP PROMPT "#" SIZE 1.

END PROGRAM STRING01.
```

SUBTRACT Statement Example

```
IDENTIFICATION DIVISION.
PROGRAM-ID.  SUBTRCT1.
*
* Examples for RM/COBOL Language Reference Manual.
* SUBTRACT statement.
*
ENVIRONMENT DIVISION.
CONFIGURATION SECTION.

DATA DIVISION.
WORKING-STORAGE SECTION.
01 TAXES                PIC S9(10)V99.
01 INCOME                PIC S9(10)V99.
01 TALLY-COUNTER        PIC S9(6).
01 TALLY-1              PIC S9(6).
01 INTEREST             PIC S9(6)V99.
01 PENALTY              PIC S9(6)V99.
01 PRINCIPAL            PIC S9(6)V99.
01 DAILY-SALES.
    02 TOPS              PIC S9(5).
```

```
02 SKIRTS          PIC S9(5) .
02 LINGERIE        PIC S9(5) .
02 SHOES           PIC S9(5) .
01 INVENTORY-ON-HAND.
02 TOPS            PIC S9(5) .
02 SKIRTS          PIC S9(5) .
02 LINGERIE        PIC S9(5) .
02 SHOES           PIC S9(5) .
PROCEDURE DIVISION.
0010.
    SUBTRACT TAXES FROM INCOME.

    SUBTRACT 1 FROM TALLY-COUNTER GIVING TALLY-1.

    SUBTRACT 2.68, INTEREST, PENALTY
      FROM PRINCIPAL ROUNDED
    ON SIZE ERROR GO TO ERROR-HANDLER.

    SUBTRACT CORR DAILY-SALES FROM INVENTORY-ON-HAND.

ERROR-HANDLER.

END PROGRAM SUBTRCT1.
```

UNLOCK Statement Example

```
IDENTIFICATION DIVISION.
PROGRAM-ID. UNLOCK01.
*
* Examples for RM/COBOL Language Reference Manual.
* UNLOCK statement.
*
ENVIRONMENT DIVISION.
CONFIGURATION SECTION.
SPECIAL-NAMES.
    C01 IS CHANNEL-1.
INPUT-OUTPUT SECTION.
FILE-CONTROL.
    SELECT INVENTORY-FILE      ASSIGN TO DISK
                                RELATIVE ACCESS RANDOM
                                RELATIVE KEY IS
                                INVENTORY-KEY.

    SELECT DATA-BASE          ASSIGN TO DISK
                                INDEXED ACCESS DYNAMIC
                                RECORD KEY IS DB-KEY
                                FILE STATUS IS DB-STATUS.

DATA DIVISION.
FILE SECTION.
FD INVENTORY-FILE.
01 INVENTORY-RECORD          PIC X(80) .

FD DATA-BASE.
01 DB-RECORD.
```



```
    02 DB-DATA-1          PIC X(10).
    02 DB-KEY             PIC X(20).
    02 DB-DATA-2          PIC X(50).

WORKING-STORAGE SECTION.
01 DB-STATUS             PIC X(02).
01 DB-DELETE-KEY        PIC X(20).
01 INVENTORY-KEY        PIC 9(5) BINARY.
01 NEW-INVENTORY-ITEM   PIC X(80).

PROCEDURE DIVISION.
DECLARATIVES.
I-O-ERROR SECTION.
    USE AFTER STANDARD EXCEPTION PROCEDURE ON I-O.
I-O-ERROR1.
    EXIT.
END DECLARATIVES.
MAIN-01 SECTION.
0010.
    UNLOCK DATA-BASE RECORDS.

    UNLOCK INVENTORY-FILE.

END PROGRAM UNLOCK01.
```

UNSTRING Statement Example

```
IDENTIFICATION DIVISION.
PROGRAM-ID. UNSTRNG1.
*
* Examples for RM/COBOL Language Reference Manual.
* UNSTRING statement.
*
ENVIRONMENT DIVISION.
CONFIGURATION SECTION.

DATA DIVISION.
WORKING-STORAGE SECTION.
01 FIELD-COUNT          PIC S9(05) BINARY.
01 FIELD-1              PIC X(10).
01 FIELD-2              PIC X(10).
01 FIELD-3              PIC X(10).
01 DELIM-1              PIC X.
01 DELIM-2              PIC X.
01 DELIM-3              PIC X.
LINKAGE SECTION.
01 PARAMETER-1.
    02 PSIZE             PIC 9(04) BINARY (2).
    02 PSTRING.
        03 PCHAR         PIC X OCCURS 0 TO 2048 TIMES
            DEPENDING ON PSIZE.

PROCEDURE DIVISION USING PARAMETER-1.
0010.
    MOVE ZERO TO FIELD-COUNT.
```

```
UNSTRING PSTRING DELIMITED BY ";" OR "."
  INTO FIELD-1 DELIMITER IN DELIM-1
    FIELD-2 DELIMITER IN DELIM-2
    FIELD-3 DELIMITER IN DELIM-3
  TALLYING IN FIELD-COUNT
ON OVERFLOW
  DISPLAY "Too many fields in parameter."
  STOP RUN
END-UNSTRING.

END PROGRAM UNSTRNG1.
```

USE Statement Example

```
IDENTIFICATION DIVISION.
PROGRAM-ID. USE01.
*
* Examples for RM/COBOL Language Reference Manual.
* USE statement.
*
DATA DIVISION.
WORKING-STORAGE SECTION.
01 CONTINUE-FLAG PIC X(02).
PROCEDURE DIVISION.
DECLARATIVES.
I-O-ERROR SECTION.
  USE AFTER STANDARD EXCEPTION PROCEDURE ON I-O.
I-O-ERROR-ROUTINE.
  DISPLAY "Error for file in I-O open mode.".
  ACCEPT CONTINUE-FLAG POSITION 0 PROMPT.
  IF CONTINUE-FLAG = "NO" STOP RUN.
END DECLARATIVES.

END PROGRAM USE01.
```

WRITE Statement Examples

WRITE Format 1

```
IDENTIFICATION DIVISION.
PROGRAM-ID. WRITE01.
*
* Examples for RM/COBOL Language Reference Manual.
* WRITE statement (sequential I-O).
*
ENVIRONMENT DIVISION.
CONFIGURATION SECTION.
SPECIAL-NAMES.
  C01 IS CHANNEL-1.
INPUT-OUTPUT SECTION.
FILE-CONTROL.
```

```
SELECT TRANSACTION-FILE  ASSIGN TO TAPE.
SELECT PRINT-FILE       ASSIGN TO PRINTER.
SELECT REPORT-FILE      ASSIGN TO PRINTER.

DATA DIVISION.
FILE SECTION.
FD TRANSACTION-FILE.
01 TR-RECORD             PIC X(80).

FD PRINT-FILE.
01 PF-RECORD            PIC X(60).

FD REPORT-FILE          LINAGE IS 54 LINES
                        FOOTING AT 50
                        TOP 8 BOTTOM 4.
01 RF-RECORD            PIC X(60).

WORKING-STORAGE SECTION.
01 TITLE-LINE           PIC X(60).
01 DETAIL-LINE          PIC X(60).
01 LOG-FILE-STATUS     PIC X(02).
01 PAGE-COUNT           PIC 9(05) BINARY VALUE 0.

PROCEDURE DIVISION.
DECLARATIVES.
I-O-ERROR SECTION.
    USE AFTER STANDARD EXCEPTION PROCEDURE ON I-O.
I-O-ERROR1.
    EXIT.
END DECLARATIVES.
MAIN-01 SECTION.
0010.
    WRITE TR-RECORD OF TRANSACTION-FILE.

    WRITE PF-RECORD FROM TITLE-LINE
        AFTER ADVANCING PAGE.

    WRITE PF-RECORD OF PRINT-FILE
        AFTER ADVANCING CHANNEL-1.

    WRITE RF-RECORD FROM DETAIL-LINE
        AFTER ADVANCING TO LINE 10
    AT END-OF-PAGE
        ADD 1 TO PAGE-COUNT
    END-WRITE.

END PROGRAM WRITE01.
```

WRITE Format 2

```
IDENTIFICATION DIVISION.
PROGRAM-ID.  WRITE02.
*
* Examples for RM/COBOL Language Reference Manual.
* WRITE statement (relative & indexed I-O).
*
```

WRITE Statement Examples
RM/COBOL Language Examples

```
ENVIRONMENT DIVISION.
CONFIGURATION SECTION.
SPECIAL-NAMES.
    C01 IS CHANNEL-1.
INPUT-OUTPUT SECTION.
FILE-CONTROL.
    SELECT INVENTORY-FILE      ASSIGN TO DISK
                                RELATIVE ACCESS RANDOM
                                RELATIVE KEY IS
                                INVENTORY-KEY.

    SELECT DATA-BASE          ASSIGN TO DISK
                                INDEXED ACCESS DYNAMIC
                                RECORD KEY IS DB-KEY
                                FILE STATUS IS DB-STATUS.

DATA DIVISION.
FILE SECTION.
FD INVENTORY-FILE.
01 INVENTORY-RECORD          PIC X(80) .

FD DATA-BASE.
01 DB-RECORD.
    02 DB-DATA-1              PIC X(10) .
    02 DB-KEY                  PIC X(20) .
    02 DB-DATA-2              PIC X(50) .

WORKING-STORAGE SECTION.
01 DB-STATUS                  PIC X(02) .
01 DB-DELETE-KEY              PIC X(20) .
01 INVENTORY-KEY              PIC 9(5) BINARY.
01 NEW-INVENTORY-ITEM        PIC X(80) .

PROCEDURE DIVISION.
DECLARATIVES.
I-O-ERROR SECTION.
    USE AFTER STANDARD EXCEPTION PROCEDURE ON I-O.
I-O-ERROR1.
    EXIT.
END DECLARATIVES.
MAIN-01 SECTION.
0010.
    WRITE DB-RECORD OF DATA-BASE
    INVALID KEY PERFORM BAD-KEY-PROCEDURE
    END-WRITE.

    MOVE 5 TO INVENTORY-KEY.
    WRITE INVENTORY-RECORD FROM NEW-INVENTORY-ITEM
    INVALID KEY DISPLAY "Key 5 not accepted."
    NOT INVALID KEY DISPLAY "Key 5 written."
    END-WRITE.

BAD-KEY-PROCEDURE.

END PROGRAM WRITE02.
```

Index

Special Characters and Symbols

- (minus) PICTURE symbol 60

\$

\$ data-pointer data 60
\$ PICTURE symbol 60

*

* (asterisk) PICTURE symbol 60

,

, (comma) PICTURE symbol 60

.

. (period) PICTURE symbol 60

/

/ (slash) PICTURE symbol 60

+

+ (plus) PICTURE symbol 60

0

0 PICTURE symbol 60

6

66-level-description-entry 16

7

77-level-description-entry 14, 16
78-level-description-entry 16

8

88-level-description-entry 16

9

9 PICTURE symbol 60

A

A - B reserved words 72
A PICTURE symbol 60
Abbreviated combined relation condition 51
ACCEPT 24
ACCESS 12
ADD 26
ADDRESS 44, 55
ADVANCING 30, 43, 49
AFTER 36, 39, 43, 49, 69
ALL 36, 42, 48
ALPHABET 10
ALPHABETIC 36, 51
Alphabetic data 36, 57
ALPHABETIC-LOWER 51
ALPHABETIC-UPPER 51
Alphabet-name 10, 12, 15, 38, 45
ALPHANUMERIC 36
Alphanumeric data 36, 57
ALPHANUMERIC-EDITED 36
Alphanumeric-edited data 36, 57
ALSO 10, 34
ALTER 27
ALTERNATE 12
AND 42, 51, 57
ANY 34
ARE 10, 15, 16
AREA 10, 12
AREAS 12
Arithmetic statements 26, 29, 32, 38, 47
Arithmetic-expression 29, 34, 42, 51
AS 16
ASCENDING 16, 38, 45
ASSIGN 12
Asterisk PICTURE symbol 60
AT 15, 24, 30, 41, 42, 49
AUTHOR 9
AUTO 20, 24
AUTOMATIC 12
AUTO-SKIP 20, 24

B

B PICTURE symbol 60
 BACKGROUND 20
 BACKGROUND-COLOR 20
 BEEP 20, 24, 30
 BEFORE 24, 36, 39, 43, 49
 BELL 20, 24, 30
 BINARY 12, 16
 BINARY-SEQUENTIAL 80
 BLACK 80
 BLANK 16, 20
 BLINK 20, 24, 30
 BLOCK 15, 24, 30
 BLUE 80
 BOTTOM 15
 BROWN 80
 BY 16, 19, 27, 32, 36, 38, 39, 44, 47, 48, 50

C

C reserved words 72
 C01 80
 C010 80
 C011 80
 C012 80
 C02 80
 C03 80
 C04 80
 C05 80
 C06 80
 C07 80
 C08 80
 C09 80
 CALL 27, 28
 CANCEL 28
 CARD-PUNCH 80
 CARD-READER 80
 CASE-INSENSITIVE 46, 51
 CASE-SENSITIVE 46, 51
 CASSETTE 80
 Category-name 36
 CD 19
 Cd-name 19, 24, 30, 33, 41, 43, 53, 55
 CENTURY-DATE 24
 CENTURY-DAY 24
 CF 77
 CH 77
 CHARACTER 10, 12, 16, 20, 24
 CHARACTERS 10, 15, 36
 Character-string 16, 20
 PICTURE 57
 CLASS 10
 Class condition 51
 Class-name 10, 51
 CLOCK-UNITS 10

CLOSE 29
 COBOL words 72, 73, 74, 75, 76, 77, 78, 80
 COBOL, ENTER statement 33
 CODE 77
 Code-name 10, 80
 CODE-SET 12, 15
 COL 20, 24, 30, 69
 COLLATING 10, 12, 38, 45
 Color-name 20, 80
 COLUMN 20, 24, 30, 69
 Combined condition 51
 COMMA 10
 Comma PICTURE symbol 60
 Commands
 Compile 1
 Debug 4
 Runtime 3
 Comment-entry 9
 Comment-text 69
 COMMON 9, 70
 COMMUNICATION 14
 Communication statements 24, 30, 33, 41, 43
 Communication-description-entry 14, 19
 COMP 16
 COMP-1 16
 COMP-3 16
 COMP-4 16
 COMP-5 16
 COMP-6 16
 Compile commands 1
 COMPUTATIONAL 16
 COMPUTATIONAL-1 16
 COMPUTATIONAL-3 16
 COMPUTATIONAL-4 16
 COMPUTATIONAL-5 16
 COMPUTATIONAL-6 16
 COMPUTE 29
 Computer-name 10, 80
 Concatenation expression 54, 56
 Condition 34, 35, 39, 42, 51
 Conditional-statement 54
 Condition-name 10, 16, 42, 44, 51, 53, 55
 Condition-name condition 51
 CONFIGURATION 10
 CONSOLE 10, 80
 Constant-expression 16, 54, 57
 Constant-name 16
 CONTAINS 10, 15
 CONTENT 27
 Context-sensitive words 78
 CONTINUE 29
 CONTROL 24, 30
 Control statements 27, 28, 29, 33, 34, 35, 39, 42, 46
 CONTROLS 77
 CONVERT 24, 30
 CONVERTING 36

COPY 50
 COPY and REPLACE statements 50
 CORR 26, 38, 47
 CORRESPONDING 26, 38, 47
 COUNT 19, 24, 48, 55
 COUNT-MAX 55
 COUNT-MIN 55
 CR (credit) PICTURE symbol 60
 CRT 10
 cs PICTURE symbol 60
 CURRENCY 10
 CURRENCY SIGN clause 60
 Currency symbol PICTURE symbol 60
 CURSOR 10, 24
 CYAN 80
 CYCLE 34

D

D reserved words 73
 DATA 14, 15, 36, 41, 70, 71
 Data Manipulation statements 36, 38, 44, 47, 48
 Data-description-entry 16
 Data-division 9, 14
 Data-name 10, 12, 15, 16, 19, 23, 24, 38, 41, 42, 44,
 45, 46, 53, 55, 57
 DATA-POINTER 36
 DATE 19, 24
 DATE-AND-TIME 24
 DATE-COMPILED 9, 24, 57
 DATE-WRITTEN 9
 DAY 24
 DAY-AND-TIME 24
 DAY-OF-WEEK 24
 DB (debit) PICTURE symbol 60
 DE 77
 Debug commands 4
 DEBUG-CONTENTS 77
 DEBUGGING 10
 DEBUG-ITEM 77
 DEBUG-LINE 77
 DEBUG-NAME 77
 DEBUG-SUB-1 77
 DEBUG-SUB-2 77
 DEBUG-SUB-3 77
 DECIMAL-POINT 10, 60
 DECLARATIVES 23, 24
 DEFAULT 36
 DELETE 29
 DELIMITED 47, 48
 DELIMITER 12, 48
 Delimiter-name 12, 80
 DEPENDING 15, 16, 35
 DESCENDING 16, 38, 45
 DESTINATION 19
 DETAIL 77

Device-name 12, 80
 Directives 54, 69
 DISABLE 30
 DISC 80
 DISK 80
 DISPLAY 12, 16, 20, 30
 DIVIDE 32
 DIVISION 9, 10, 14, 23, 24, 70, 71
 DOWN 44
 DUPLICATES 12, 45
 DYNAMIC 12

E

E reserved words 73
 EBCDIC 80
 ECHO 24
 EGI 43
 ELSE 35
 EMI 43
 ENABLE 33
 END 10, 19, 23, 24, 41, 42, 50, 69, 70, 71
 END-ACCEPT 24
 END-ADD 26
 END-CALL 27, 28
 END-COMPUTE 29
 END-COPY 50
 END-DELETE 29
 END-DIVIDE 32
 END-EVALUATE 34
 END-IF 35
 END-MULTIPLY 38
 END-OF-PAGE 49
 END-PERFORM 39
 End-program-header 9, 50
 END-READ 41
 END-RECEIVE 41
 END-REPLACE 50
 END-RETURN 42
 END-REWRITE 42
 END-SEARCH 42
 END-START 46
 END-STRING 47
 END-SUBTRACT 47
 END-UNSTRING 48
 END-WRITE 49
 ENTER 33
 ENVIRONMENT 10, 70, 71
 Environment-division 9, 10
 EOL 20, 24, 30
 EOP 49
 EOS 20, 24, 30
 EQUAL 42, 46, 51
 ERASE 20, 24, 30
 ERROR 19, 26, 29, 32, 38, 47, 49
 ESCAPE 24

ESI 43
 EVALUATE 34
 EVERY 10
 EXCEPTION 24, 27, 28, 49
 EXCLUSIVE 12, 39, 57
 EXIT 34
 Expression 29, 34, 35, 39, 42, 51, 55, 63
 arithmetic 29, 34, 42, 51, 55
 conditional 34, 35, 39, 42, 51
 regular 63
 EXTEND 39, 49
 EXTERNAL 15, 16

F

F - I reserved words 74
 FALSE 16, 34, 44
 FD 15
 Feature-name 10, 80
 Figurative-constants 54, 56
 FILE 10, 12, 14, 29
 FILE-CONTROL 10
 File-control-entry 10, 12
 File-description-entry 14, 15
 FILE-ID 80
 File-name 10, 12, 15, 29, 38, 39, 41, 42, 45, 46, 48,
 49, 53, 55
 FILLER 16, 20, 36
 FINAL 77
 FIRST 36, 46
 FIXED 77
 FOOTING 15
 FOR 10, 19, 29, 36
 FOREGROUND 20
 FOREGROUND-COLOR 20
 FROM 15, 20, 24, 39, 42, 43, 47, 49
 FULL 20
 FUNCTION 77

G

General format for a sequence of source programs 70
 General format for nested source programs 70
 General format for *nested-source-program* 70
 GENERATE 77
 GIVING 23, 24, 26, 27, 32, 38, 45, 47
 GLOBAL 15, 16, 49
 GO 35
 GOBACK 35
 GREATER 46, 51
 GREEN 80
 GROUP 77

H

HEADING 77

HIGH 24, 30
 HIGHEST-VALUE 55
 HIGHLIGHT 20, 24, 30
 HIGH-VALUE 56
 HIGH-VALUES 56

I

ID 9, 70, 71
 IDENTIFICATION 9, 70, 71
 Identification-division 9
 Identifier 20, 24, 26, 27, 28, 29, 30, 32, 33, 34, 35,
 36, 38, 39, 41, 42, 43, 44, 46, 47, 48, 49, 50, 51,
 54, 55
 IF 35
 IMP 69
 Imperative-statement 24, 26, 27, 28, 29, 32, 34, 38,
 39, 41, 42, 46, 47, 49, 54
 IN 10, 15, 44, 45, 48, 50, 53, 55
 Index 60
 INDEX 16
 INDEXED 12, 16, 19
 Index-name 16, 19, 39, 42, 44, 51, 53, 55
 INDICATE 77
 INITIAL 9, 19, 36, 70, 71
 INITIALIZE 36
 INITIAL-VALUE 55
 INITIATE 77
 INPUT 12, 19, 30, 33, 39, 45, 49
 INPUT-OUTPUT 10, 12
 INSPECT 36
 INSTALLATION 9
 Integer 10, 12, 15, 16, 19, 20, 24, 30, 39, 43, 44, 46,
 49, 55, 57
 INTO 32, 41, 42, 47, 48
 INVALID 29, 41, 42, 46, 49
 I-O 19, 30, 33, 39, 49
 I-O statements 29, 39, 41, 42, 46, 48, 49
 I-O-CONTROL 10
 IS 9, 10, 12, 15, 16, 19, 20, 24, 30, 38, 41, 42, 45, 46,
 51, 69, 70, 71

J

J - N reserved words 75
 JUST 16, 20, 55
 JUSTIFIED 16, 20, 55

K

KEY 12, 16, 19, 24, 29, 30, 33, 38, 41, 42, 45, 46, 49
 KEYBOARD 80

L

LABEL 15

Label-name 15, 80
 Language-name 33, 80
 LAST 46
 LEADING 10, 16, 20, 36
 LEFT 16, 46, 51
 Leftmost-character-position 55
 LENGTH 19, 44, 55, 57
 Length-1 55
 LESS 46, 51
 Level-number 16, 20
 Library-name 50, 53
 LIKE 51
 LIKE condition 51, 54, 63
 LIMIT 77
 LIMITS 77
 LINAGE 15
 LINAGE-COUNTER 53, 55
 LINE 12, 20, 24, 30, 43, 49
 LINE-COUNTER 77
 LINES 15, 43, 49
 LINE-SEQUENTIAL 80
 LINKAGE 14, 33
 LISTING 69, 80
 Literal 9, 10, 12, 15, 16, 20, 24, 26, 27, 28, 30, 32,
 33, 34, 36, 38, 42, 43, 46, 47, 48, 49, 50, 51, 55,
 56, 57, 70, 71
 LOCK 12, 29, 39, 41
 LOW 24, 30
 Low Volume I-O statements 24, 30
 LOWEST-VALUE 55
 LOWLIGHT 20, 24, 30
 LOW-VALUE 56
 LOW-VALUES 56
 Low-volume-I-O-name 10, 24, 30, 80

M

MAGENTA 80
 MAGNETIC-TAPE 80
 MANUAL 12
 MARGIN-R 69
 MAX-VALUE 55
 MEMORY 10
 MERGE 12, 38
 MESSAGE 19, 24, 41
 Minus PICTURE symbol 60
 MIN-VALUE 55
 Miscellaneous formats 54
 Mnemonic-name 10, 24, 30, 43, 44, 49
 MODE 10, 12, 24, 30
 MODULES 10
 MOVE 38
 MULTIPLE 10, 12
 MULTIPLY 38

N

NATIVE 10
 Negated condition 51
 NEGATIVE 51
nested-source-program 9, 70, 71
 NEXT 24, 35, 41, 42, 49, 57
 NO 12, 20, 24, 29, 30, 39, 41
 NOT 24, 26, 27, 29, 32, 34, 38, 41, 42, 46, 47, 48, 49,
 51, 57
 NULL 44, 56
 NULLS 44, 56
 NUMBER 20, 24, 30
 NUMERIC 10, 36, 51
 Numeric data 36, 57
 NUMERIC-EDITED 36
 Numeric-edited data 36, 57

O

O - Q reserved words 75
 OBJECT-COMPUTER 10
 OCCURS 16, 19
 OF 10, 15, 44, 50, 53, 55, 57, 69
 OFF 10, 24, 44, 50, 69
 OMITTED 15, 27, 28
 ON 10, 12, 15, 16, 24, 26, 27, 28, 29, 32, 35, 38, 44,
 45, 47, 48, 49, 69
 OPEN 39
 OPTIONAL 12
 OR 46, 48, 51, 57
 ORDER 45
 ORGANIZATION 12
 OTHER 34
 OUTPUT 12, 19, 30, 33, 38, 39, 45, 49
 OVERFLOW 27, 47, 48

P

P PICTURE symbol 60
 PACKED-DECIMAL 16
 PADDING 12
 PAGE 43, 49, 69
 PAGE-COUNTER 77
 PARAGRAPH 34, 55
 Paragraph-name 23, 24, 53
 Pattern 63
 LIKE 63
 PERFORM 39
 Period PICTURE symbol 60
 PF 77
 PH 77
 PIC 16, 20
 PICTURE 16, 20, 57
 PICTURE character-string 54, 57
 PICTURE symbols 54, 60

PLUS 20
 Plus PICTURE symbol 60
 POINTER 16, 47, 48
 POSITION 10, 24, 30
 POSITIVE 51
 PREVIOUS 41
 PRINT 80
 PRINTER 80
 PRINTER-1 80
 PRINTING 50
 PROCEDURE 23, 24, 38, 45, 49, 55, 70, 71
 Procedure-division 9, 23, 24
 Procedure-name 27, 35, 38, 39, 45
 PROCEDURE-NAME 55
 PROCEDURES 77
 PROCEED 27
 PROGRAM 9, 10, 28, 34, 50, 70, 71
 Program structure 70, 71
 PROGRAM-ID 9, 55, 70, 71
 Program-name 9, 50, 70, 71
 PROMPT 24
 Pseudo-text 50
 PURGE 41

Q

Qualification 53
 QUEUE 19
 QUOTE 56
 QUOTES 56

R

R reserved words 76
 RANDOM 12
 RD 77
 READ 41
 RECEIVE 41
 RECORD 10, 12, 15, 29, 41, 42, 48, 69
 Record-description-entry 14, 16
 RECORDING 77
 Record-name 42, 49
 RECORDS 10, 12, 15, 48
 RED 80
 REDEFINES 16
 REEL 10, 29
 REFERENCE 27
 Reference modification 54, 55
 REFERENCES 77
 Regular expression 63
 Relation condition 51
 Relational operator 16, 51
 RELATIVE 12
 RELEASE 42
 REMAINDER 20, 32
 REMARKS 9

REMOVAL 29
 RENAMES 16
 REPLACE 50
 REPLACING 36, 43, 50
 REPORT 77
 REPORTING 77
 REPORTS 77
 REQUIRED 20
 RERUN 10
 Rerun-name 10, 80
 RESERVE 12
 Reserved words 72, 73, 74, 75, 76, 77
 A - B 72
 C 72
 context-sensitive 78
 D 73
 E 73
 F - I 74
 J - N 75
 O - Q 75
 R 76
 S 76
 T - Z 77
 unused reserved words 77

RESET 77
 RETURN 42
 RETURN-CODE 55
 RETURNING 23, 24, 27
 REVERSE 20, 24, 30
 REVERSED 20, 24, 30, 39
 REVERSE-VIDEO 20, 24, 30
 REWIND 29, 39
 REWRITE 42
 RF 77
 RH 77
 RIGHT 16, 20, 46, 51, 55
 rmcobol 1
 ROUNDED 26, 29, 32, 38, 47
 Routine-name 33
 RUN 46
 runcobol 3
 Runtime commands 3

S

S PICTURE symbol 60
 S reserved words 76
 SAME 10, 16
 SCREEN 14, 20
 Screen-description-entry 14, 20
 Screen-name 20, 24, 30, 53
 SD 15
 SEARCH 42
 SECTION 10, 14, 23, 24, 34, 55
 Section-name 23, 24, 53
 SECURE 20, 24

SECURITY 9
 SEGMENT 41
 SEGMENT-LIMIT 10
 Segment-number 10, 23, 24
 SELECT 12
 SEND 43
 Sentence 54
 miscellaneous formats 54
 procedure division general formats 23, 24
 sentence 54
 SENTENCE 24, 35, 42
 SEPARATE 10, 16, 20
 SEQUENCE 10, 12, 38, 45
 SEQUENTIAL 12
 SET 16, 44
 SIGN 10, 16, 20
 Sign condition 51
 SIZE 10, 15, 24, 26, 29, 30, 32, 38, 46, 47, 57
 Slash PICTURE symbol 60
 SORT 10, 12, 45
 SORT-MERGE 10, 12
 Sort-Merge statements 38, 42, 45
 Sort-merge-file-control-entry 12
 Sort-merge-file-description-entry 14, 15
 SORT-WORK 80
 SOURCE 19
 SOURCE-COMPUTER 10
 Source-program 9
 SPACE 56
 SPACES 56
 Special registers 54, 55
 SPECIAL-NAMES 10
 Split-key-name 12, 41, 46, 53
 STANDARD 15, 49
 STANDARD-1 10, 12
 STANDARD-2 10
 START 46, 57
 Statements
 Arithmetic 26, 29, 32, 38, 47
 Communication 24, 30, 33, 41, 43
 Control 27, 28, 29, 33, 34, 35, 39, 42, 46
 COPY and REPLACE 50
 Data Manipulation 36, 38, 44, 47, 48
 I-O 29, 39, 41, 42, 46, 48, 49
 Low Volume I-O 24, 30
 Sort-Merge 38, 42, 45
 Statement-sequence 54
 STATUS 10, 12, 19, 24
 STOP 46
 STRING 47
 SUB-QUEUE-1 19
 SUB-QUEUE-2 19
 SUB-QUEUE-3 19
 Subscript 55
 Subscripting 54, 55
 SUBTRACT 47

SUM 77
 SUPPRESS 50
 Switch status condition 51
 Switch-name 10, 80
 SYMBOLIC 10, 19
 Symbolic-character 10, 56
 Symbols, PICTURE 60
 SYNC 16
 SYNCHRONIZED 16
 SYSIN 80
 SYSOUT 80
 System-name 80

T

T - Z reserved words 77
 TAB 24
 TABLE 19
 TALLYING 36, 48
 TAPE 10, 12
 TERMINAL 19, 30, 33
 TERMINATE 77
 TEST 39
 TEXT 19
 Text-name 50, 53
 THAN 46, 51
 THEN 35, 36, 54
 THROUGH 10, 16, 34, 38, 39, 45
 THRU 10, 16, 34, 38, 39, 45
 TIME 19, 24
 TIMES 16, 19, 39
 TO 12, 15, 16, 20, 26, 27, 35, 36, 38, 42, 44, 46, 49,
 51
 TOP 15
 TRAILING 10, 16, 20, 36
 TRIMMED 46, 51
 TRUE 34, 44
 TYPE 77

U

UNDERLINE 20
 Unicode property category escapes 68
 UNIT 10, 24, 29, 30
 UNLOCK 48
 UNSTRING 48
 UNTIL 39
 Unused reserved words 77
 UP 44
 UPDATE 24
 UPON 30
 USAGE 16, 20
 USE 23, 24, 49
 USE statement 23, 24, 49
 USING 20, 23, 24, 27, 28, 38, 45

V

V PICTURE symbol 60
VALUE 15, 16, 20, 36
VALUES 16
VARIABLE 77
VARYING 15, 39, 42

W

WHEN 16, 20, 34, 42
WHEN-COMPILED 55
WHILE 46
WHITE 80
WITH 10, 12, 15, 24, 29, 30, 33, 36, 39, 41, 43, 45,
46, 47, 48
Word 50
WORDS 10
Words reserved 72, 73, 74, 75, 76, 77
A - B 72
C 72
D 73
E 73
F - I 74
J - N 75
O - Q 75
R 76
S 76
T - Z 77
WORKING-STORAGE 14
WRITE 49

X

X PICTURE symbol 60

Y

YYYYDDD 24
YYYYMMDD 24

Z

Z PICTURE symbol 60
ZERO 16, 20, 51, 56
ZEROES 56
ZEROS 56